

OPERATOR MANUAL



**Post-Column
Derivatization
Instrument**



1280 Space Park Way
Mountain View
CA 94043
USA

800-654-3330 • 650-694-6700

650-968-0749 FAX

www.pickeringlabs.com

support@pickeringlabs.com

<http://pickeringlabs.blogspot.com>

Cat. No. 0101-0008

Version 10, April 2016

Copyright © 2005 by Pickering Laboratories, Inc. All rights reserved. No Portion of this manual or any artwork contained herein may be reproduced in any shape or form without the express written consent of Pickering Laboratories, Inc.

TABLE OF CONTENTS

1 Getting Started

- How to Use this Manual 1
- Read this First! 2
- Symbols and Warnings 2
- Specifications 2
- Site Requirements 4

1.1 Section 1 Introduction

- What is Post-column Derivatization? 1.1
- Requirements for a Successful Post-column Method 1.1
- Design of a HPLC system 1.2
- Designing a Post-column System 1.4
- Design of the Pinnacle PCX 1.6

2.1 Section 2 Overview

- Introduction 2.2
- Check Valve 2.3
- Column Connections and Column Oven 2.3
- Reagent Pump 2.4
- Reagent Valves 2.5
- Reservoir Tray / Bottles 2.5
- Fluidics Panel 2.7
- Quick Change Reactor 2.8
- Detector Connections 2.8
- Pump Compartment 2.9
- Gas Manifold 2.9
- Display Module 2.10
- Electronics Compartment 2.11
- Back Panel 2.11
- Safety Features in the Pinnacle PCX 2.13
- Standard Configurations of Pinnacle PCX 2.14

3.1 Section 3 Installation

- Site Requirements **3.2**
- Instrument Unpacking and Preparation **3.4**
- Unpacking **3.4**
- Gas Connections to Back Panel of Pinnacle PCX **3.5**
- Computer Connections **3.6**
- Software Installation **3.6**
- Pump and Autosampler Connections **3.8**
- Eluant Priming **3.10**
- Column and Guard Installation **3.10**
- Detector Connections **3.11**
- Reservoir Connections **3.12**
- Reagent Pump Preparation **3.13**
- Running a Chromatogram **3.14**
- Shutdown **3.15**

4.1 Section 4 Pinnacle PCX Operation

- Software Overview **4.1**
 - Status Window **4.2**
 - Menu Options/Functions **4.4**
 - File
 - Control
 - Method
 - Sequence
 - Instrument
 - Configuring your Pinnacle PCX **4.6**
 - Log Files **4.7**
 - Creating and Editing Methods **4.7**
 - Creating and Editing Sequences **4.10**
 - Tutorials **4.11**
 - Running post-column analysis using Pinnacle PCX **4.14**
 - STOP/RESET Pinnacle PCX **4.17**
 - Pinnacle Shutdown **4.17**
-

5.1 Section 5 Maintenance

- Maintenance Suggestions 5.1
- Operating Suggestions 5.2
- Proper Shutdown Procedures 5.3
- Basic Maintenance Procedures 5.6
- Reagent Filter(s) Replacement 5.7
- Ambient Reactor Replacement 5.8
- Replacement of Heated Reactor Cartridge 5.8
- Valve Maintenance 5.9
- Pump Seal Replacement 5.12
- Fuse Replacement 5.16
- Tubing Kit Guides 5.17

6.1 Section 6 Applications

- Amino Acids 6.2
 - Introduction 6.2
 - Background 6.2-1
 - Basic Sample Preparation 6.2-2
 - Reagent Preparation 6.2-3
- Post-Column Conditions 6.2-4
 - Procedure 6.2-5
 - Sample Chromatograms and Gradient Programs 6.2-6
 - Precautions 6.2-18
- Carbamates 6.3
 - Introduction 6.3
 - Background 6.3
 - Basic Sample Preparation 6.3-2
 - Reagent Preparation 6.3-3
 - Post-Column Conditions 6.3-5
 - Analytical Procedure 6.3-5
 - Sample Chromatograms and Gradient Programs 6.3-5
 - Precautions 6.3-12

Glyphosate	6.4
Introduction	6.4
Background	6.4-1
Basic Sample Preparation	6.4-1
Reagent Preparation	6.4-2
Analytical and Post-Column Conditions	6.4-4
Analytical Procedure	6.4-4
Sample Chromatograms	6.4-5
Precautions	6.4-6

7.1 Section 7 Troubleshooting

Contact Pickering Laboratories For Support	7.1
Instrument Parameter Log	7.2
General Troubleshooting Advice	7.2
Common System Problems	7.3
Common Chromatography Problems	7.4
Common Column Problems	7.6
Application Specific Troubleshooting	7.7
• Amino Acids	
• Carbamates	
• Glyphosate	
Amino Acid	7.7
Software Troubleshooting	7.8
Procedures	7.11
• To Remove Silica Deposits From Reactor	
• To Remove Mineral Deposits In The Reactor From Hard Water	
• To Remove Grease Deposits	
• If Reagent Backflows Onto Column	
• If TRIONE Backflows Onto Column	
• If NaOH Is On Column	
• To Remove Iron Contamination From Column	
• To Pump RESTORE Through The Glyphosate Column	

8.1 Appendices

- Installation/Operational Qualitication of the Pinnacle PCX **8.2**
- Installation/Operational Qualitication of the Pinnacle PCX Data Sheet **8.7**
- Performance Qualifications of the Pinnacle PCX Data Sheet **8.8**
- Sample Instrument Parameter Log **8.15**
- Flow Diagram – Simplex **8.16**
- Flow Diagram – Duplex **8.17**
- Parts List for Pinnacle PCX **8.18**
- Recommended Consumables and Spare Parts **8.21**
- Limited Warranty **8.24**
- References **8.25**

9.1 Index

GETTING STARTED

- 1** How to Use this Manual
- 2** Read this First!
- 2** Symbols and Warnings
- 2** Specifications
- 4** Site Requirements

How to Use this Manual

The Pinnacle PCX manual is designed to contain all of the information necessary for the installation, operation, maintenance and troubleshooting of the Pinnacle PCX. It is designed to contain any and all information that you may require during the lifetime of your Pinnacle PCX.

In addition to the general operation information, this manual also contains sections devoted to a particular application. Since Pickering Laboratories provides the complete solution, we included the chromatograms, operating conditions, and some troubleshooting information for our most commonly supported methods.

As well as instructional information, this manual also contains a section for recording service information such as serial numbers, installation dates, service dates etc.

Each section of the manual is divided by a tab with the title of that section. For easy reference, simply select the tab that you require based on the information you are looking for. For example, if you are running Amino Acids, and have a question about the gradient program, simply go to the section titled "Amino Acids".

Read this First!

Before attempting to install the Pinnacle PCX post-column derivatization instrument, it is vitally important that you read this manual first, and attend to site, HPLC, and accessories requirements:

HPLC – Page 5

Gas Supply Requirements – Page 5

Reagent Reservoir bottles – Page 5

Computer – Page 5

Symbols and Warnings



Caution – this symbol indicates that caution must be used when dealing with this part.



Hot – this symbol is located on the Heated reactor, which can reach scalding temperatures.

Specifications

INSTRUMENT

Dimensions

21.50 H x 10.63 W x 18.25 D inches (54.0 x 26.7 x 46.4 cm), instrument only, doors closed

Weight

77lbs for Dual-pump systems

67lbs for Single-pump systems

Reagent Pumps

Max operating pressure 500 psi (35bar)

Flow rate range 50µl –1500µl/minute

Refill cycle 60 seconds

Heated Reactor

5°C above ambient to 130°C

Thermal Safety switch limits temperature to 150°C

Stability +/- 0.5°C

Accuracy +/- 1°C

Electrical

720 W

120 VAC +/- 10%, 240 VAC +/- 10%

5 A maximum at 108 VAC

47 – 63 Hz

Installation over voltage category: Pinnacle PCX complies with Class B Emission Test Specifications.

Fuses

2 ea, 5mm x 20 mm, 6 A, time lag

LCD

Backlit, positive mode, high contrast, viewing area – 125mm (L) x 75mm (W)

COMMUNICATION**USB**

Requires a USB port.

Relay

Any machine that drives this relay input shall provide a relay contact pair that is electrically isolated from all other electrical devices. The relay contacts must be capable of switching 1mA at 24 +/- 2 Vdc.

Ethernet (optional) Connector: RJ45

Connection Speed: 10/100-BASE-T

Ethernet Protocol: TCP/IP

IP Address: User set or DHCP (DHCP requires the Network Administrator to “Reserve” an IP address with the DHCP server)

Note: Recommend connection to a Network Switch or Router, or direct connection to a dedicated Network card in the PC.

ENVIRONMENTAL

Indoor use only

Altitude up to 6500 ft (1981 m)

Ambient Temperature – 40°C

Relative Humidity up to 80% at 31°C

Radio Frequency Pinnacle PCX complies with IEC 61000-4-3

This device complies with Part 15 CHECK Class B of the FCC Rules. Operation is subject to the following two conditions: (1) This device may not cause harmful interference, and (2) this device must accept any interference received, including interference that may cause undesired operation.

WETTED MATERIALS

- PEEK, PTFE, Air Barrier Tubing
- 99.9% Ceramic
- Perlast®
- Borosilicate glass
- EPR

SOFTWARE

PCX Control Software runs on Microsoft Windows XP, Vista, or Windows 7.
10Mb hard disk space

PCX History Log file: Maximum file Size on the computer: 1.2 Mb

Site Requirements**INSTRUMENT****Bench Space**

33 H x 17 W x 21 D inches (84 x 56 x 59 cm), both doors fully opened, with bottles and electrical connections in place.

Minimum 3 inches clearance at back of instrument for venting.

Note: Space quoted above is for Pinnacle PCX.

The total space requirement depends on the brand and model of HPLC.

Electrical Outlet

One grounded outlet must be provided for the Pinnacle PCX.

Computer

IBM-compatible

PCX Control Software runs on Microsoft Windows XP, Vista, or Windows 7.

Ethernet or USB port

Available Memory: Minimum 10Mb

Ethernet (optional) Connector: RJ45

Connection Speed: 10/100-BASE-T

Ethernet Protocol: TCP/IP

IP Address: User set or DHCP (DHCP requires the Network Administrator to “Reserve” an IP address with the DHCP server)

Note: Recommend connection to a Network Switch or Router, or direct connection to a dedicated Network card in the PC.

Relay

For synchronization, the HPLC system must be capable of sending a relay signal to an external instrument.

No relay connection is needed for Agilent 1100 or Agilent 1200. Pinnacle PCX software directly synchronizes with Chemstation version 9.0 or higher.

Gas Supply

High purity Nitrogen, 45-75 psi (min - max)

Outlet of regulator must connect to 1/8” OD tubing

Reagent Reservoir Bottles

The Pinnacle PCX includes one pressurized reagent reservoir for the one reagent system and two for the two reagent system.

Note: For your safety, the bottles are coated with a tough plastic film and rated to a maximum of 15 psig (1 bar). Do not use uncoated bottles.

HPLC Pump

Binary gradient for glyphosate, carbamate applications.

Quaternary for all others.

Autosampler

Minimum injection volume 10µl, preferably by full-loop injection

For drinking water, minimum injection volume 200µl

Tefzel rotor seal required for all applications using eluants with pH>10

PEEK needle seat required for all applications using eluants with pH>10

Detector

Pressure rating of flow cell must be > 110 psi

Inlet capillary must be > 0.17 mm ID

MISCELLANEOUS SUPPLIES

For Amino Acid analysis, a Dead-Head kit is required. This can be purchased from Pickering Laboratories.

Chemistry

The user must check the chemistry requirements for the specific application.

For Carbamate Analysis

HPLC Grade Methanol

HPLC Grade Water

Materials for calibration standards

Carbamate hydrolysis reagent (Cat. No. CB910)

Carbamate OPA diluent (Cat. No. CB130 or CB130.2)

o-phthalaldehyde (Cat. No. O120)

Thiofluor™ (Cat. No. 3700-2000)

For Glyphosate Analysis

5% Sodium hypochlorite solution

Materials for calibration standards

Methanol for OPA reagent preparation

Glyphosate Eluant, pH2.0 (Cat. No. K200)

Glyphosate Regenerate (Cat. No. RG019)

Glyphosate Hypochlorite diluent (Cat. No. GA116)

Glyphosate OPA diluent (Cat. No. GA104)

o-phthalaldehyde (Cat. No. O120)

Thiofluor™ (Cat. No. 3700-2000)

For Amino Acid Analysis**A: Fluorescence detection**

- Methanol for OPA reagent preparation
- 5% Sodium hypochlorite if using the 2-reagent method
- Brij 35 solution for OPA reagent preparation
- DI Water
- Pickering sodium or lithium elution buffers
(see application section for cat. nos.)

B: UV – Visible detection

- DI Water
- TRIONE® Ninhydrin reagent (cat. no. T100C or T200)
- Pickering sodium or lithium elution buffers
(see application section for cat. nos.)

Notes

Section 1

INTRODUCTION

- 1.1 What is Post-column derivatization?
- 1.1 Requirements for a Successful Post-column Method
- 1.2 Design of a HPLC system
- 1.4 Designing a Post-column system
- 1.6 Design of the Pinnacle PCX

What is Post-column Derivatization?

This is a method which renders visible certain compounds that are normally invisible. Since this reaction occurs after, or post-separation, it is referred to as post-column derivatization. The analytes of interest are separated on the column first, and then reacted with a chemical that will render them detectable at a desirable wavelength, voltage, or any number of various means of detection.

Post column derivatization enhances the sensitivity of HPLC by several means:

- 1) Most reagents are selective for a particular class of substances, so analytes of that class are more easily seen against a complex background.
- 2) Since the separation is performed first, the matrix of the sample is either washed off of the column before the analytes, or is retained by the column. This leaves a very pure sample of analyte to react. This eliminates the need for extensive sample clean-up, and provides a very reproducible reaction because there are no matrix interferences.

The Pinnacle PCX post-column derivatization instrument automatically mixes the stream of effluent flowing from the HPLC column with a stream of reagent solution. The mixture flows through a reactor to allow enough time for the chemical reactions to complete. In many cases, the reaction is very slow at room temperature. For this reason, the reactor can be heated. There are some methods that require two or more reagents added in sequence. This is done by the addition of a second reagent pump. In many cases, the second reaction occurs at a much faster rate, and can be efficiently accomplished at room temperature. After the reaction is complete, the derivatives flow into the detector, where the absorbance or the fluorescence (usually) is measured by the HPLC system. These two means of detection are the most common, but they are certainly not the only means of detection.

Requirements for a Successful Post-column Method

There are many things to take into consideration when developing a method and instrument for post-column derivatization. For example, many pumps have a periodic motion when drawing and dispensing that

will manifest itself in the baseline of a chromatogram unless it is properly dampened. Below are the basic requirements for a successful automated post-column method:

- 1) **Reagent Stability.** The minimum reagent stability sufficient for routine work is one day. This means that the yield and signal-to-noise ratio for a given sample must remain constant for at least 8 hours.
- 2) **Reaction Speed.** The analytical separation is complete when the reagent is mixed with the column effluent. Therefore it is important that the analyte react as quickly as possible. The longer the reaction time, the larger the reactor volume required. With larger volumes, the peak shape will become distorted. To minimize band spreading, it is important to keep the overall time (and therefore volume) as low as possible between the column and detector. If the reaction is slow (in excess of one minute), an elevated temperature can be used to decrease the reaction time.
- 3) **Reproducibility.** Because the reaction is occurring “on the fly,” as the combined column and reagent stream flows toward the detector, the reproducibility is linked to the flow rate precision of the pumps and to the temperature. Accordingly, even an incomplete reaction will be as repeatable as the retention time for any given species. Therefore, it is important that the pumps maintain a constant flow rate, and that the reactor maintain a constant temperature. It is also very important that the column be maintained at constant temperature to ensure that the analytes are properly separated and identified.
- 4) **Minimal Detector Response of Reagents.** The color or background fluorescence of the reagent (or its by-products) represents a continuous noise source. Because the reagent is present in excess relative to the analyte, the analyte’s signal could be obliterated by the reagent’s strong background signal. The baseline noise is proportional to the background signal.
- 5) **Solubility.** All species must remain in solution, including the combined components of the eluants and the reagent(s), as well as the newly formed derivative(s). Precipitates can block capillary tubes, burst reactors, and foul detector flow cells.
- 6) **Uniformity of flow.** The baseline noise is a function of the flow-noise in the eluant and reagent pumps. Non-uniform flow causes non-uniform mixing leading to modulation of the background signal which appears as noise. Refractive index noise can be even more objectionable than absorbance noise. Common techniques for evening the flow of the pumps is the addition of a pulse dampener, or the use of a syringe pump.

Design of a HPLC system

This next section is a simplified view of a HPLC, followed by the ideas behind a post-column system. This section is intended to help novice HPLC operators.

In order to understand post-column HPLC, we need to understand the design of an HPLC. If we connect an HPLC pump directly to a detector (with nothing in between), the baseline from the detector shows a periodic noise (Figure 1-1); the time period is equivalent to the pump stroke.

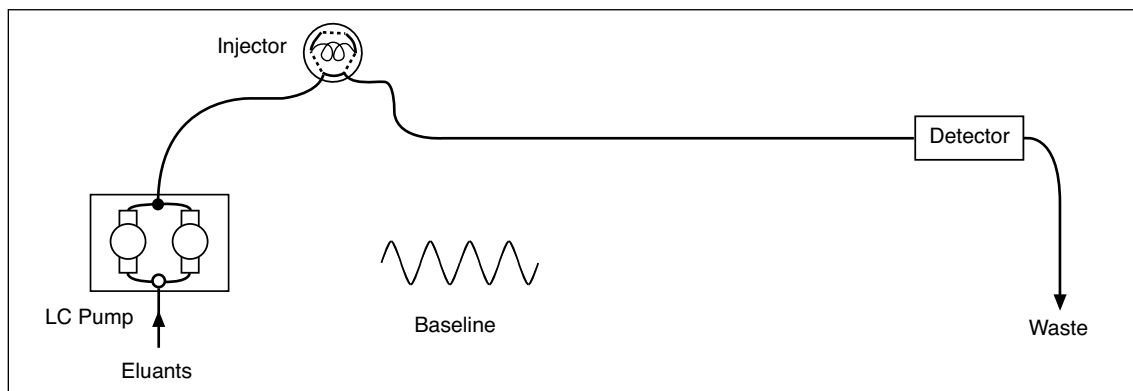

FIGURE 1-1

Now add a commercial pulse dampener. The baseline is still not smooth; the periodic noise is still there although less pronounced (Figure 1- 2). The pulse dampener absorbs most of the pulses from the pump, but the flow requires more stabilization.

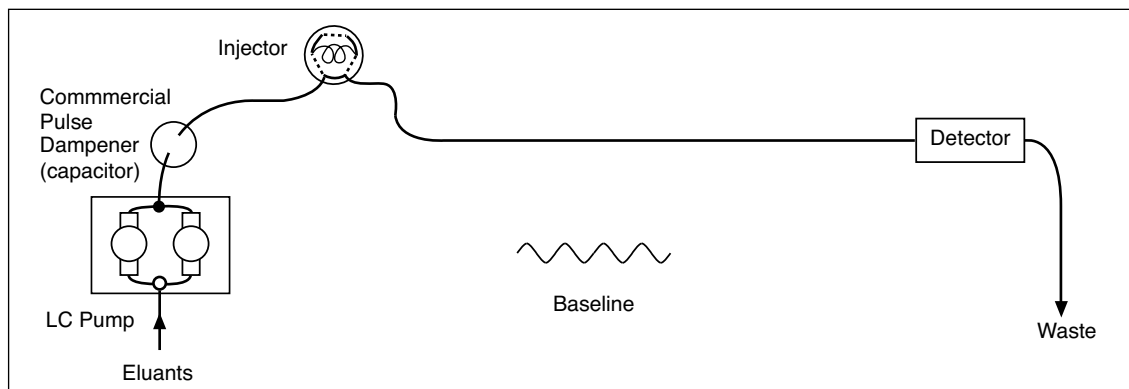

FIGURE 1-2

A restriction inline will cause the flow at the outlet of the restriction to be constant. In an HPLC system, this is accomplished with the analytical column. Actually, the column does more than separation; it creates a back-pressure. It is the combination of the pulse dampener and the column that creates a smooth baseline. (Figure 1-3)

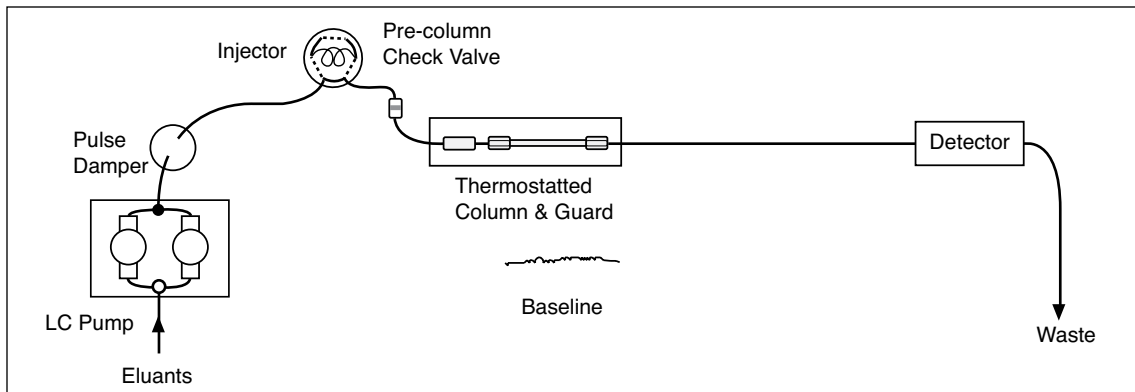

FIGURE 1-3

An analogy will help us understand the concept. Let us use a river as an example. If it rains; the river swells. If it stops raining; the level goes down. As the level fluctuates, it is equivalent to a periodic noise. To obtain a constant flow, we need to add a reservoir (pulse dampener) and a dam (column). The flow downstream from the dam is constant (smooth baseline).

Designing a Post-column System

The same principals that are used in HPLC can be applied to the post-column system. What happens if we simply add a post-column pump, a mixing tee, and a reactor? The periodic noise returns to the baseline (created by the post-column pump; Figure 1-4).

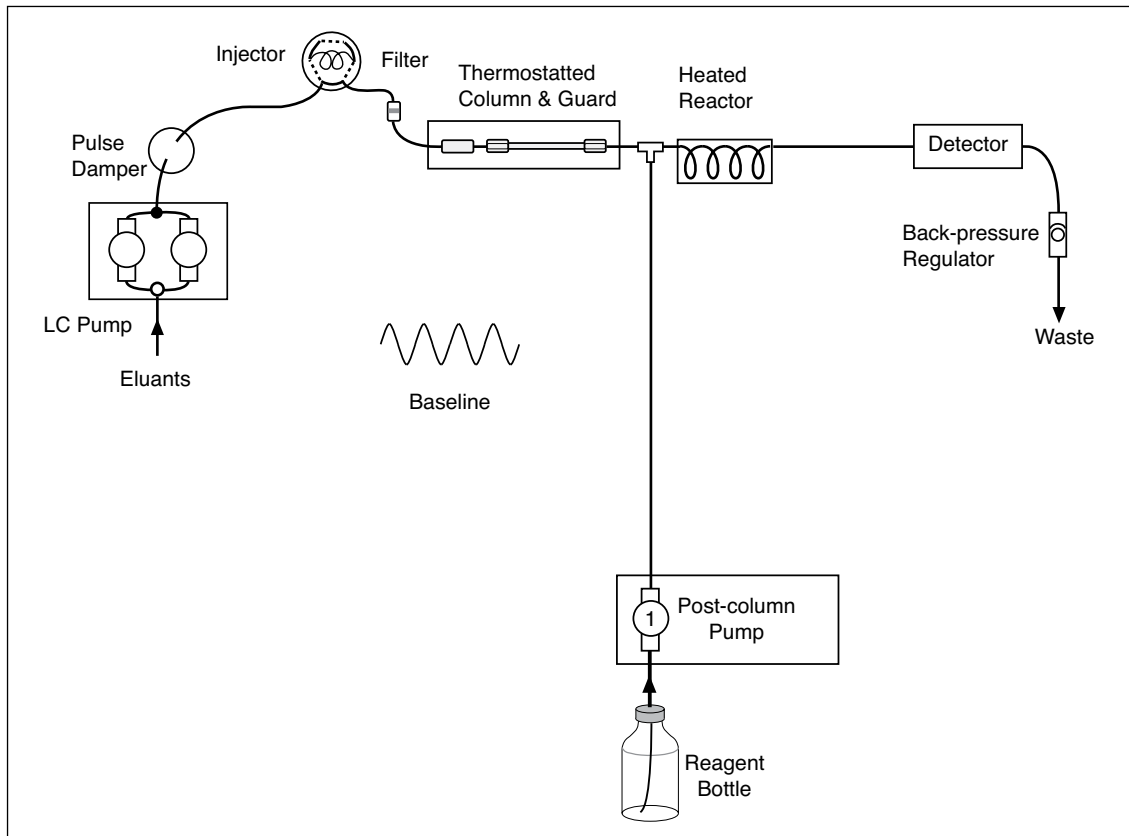

FIGURE 1-4

However we do not need to invent anything new; we just need a pulse dampener and a column. In the generation of Post-column systems prior to the Pinnacle PCX, the restriction performed by the column was achieved using a Restrictor, which is packed with very inert material. With this “flow conditioner” in place, the baseline is now acceptable.

Design of the Pinnacle PCX

The Pinnacle PCX has taken the post-column system to a new level. The introduction of a syringe pump has eliminated the need for a pulse-dampener and restrictor by:

- The Pickering syringe pumps complete a filling cycle prior to the injection of a run, and deliver reagent during the run at a constant rate.
- There is a valve between the pump and reactor which also helps to regulate the reagent flow, by opening key ports at the appropriate time.
- There is also a pressure transducer which we have added in line before the valve to determine if there are any blockages in the reactors.

Now you are ready for Section 2.

Section 2

OVERVIEW

- 2.2** Introduction
- 2.3** Check Valve
- 2.3** Column Connections and Column Oven
- 2.4** Reagent Pump
- 2.5** Reagent Valves
- 2.5** Reservoir Tray / Bottles
- 2.7** Fluidics Panel
- 2.8** Quick Change Reactor
- 2.8** Detector Connections
- 2.9** Pump Compartment
- 2.9** Gas Manifold
- 2.10** Display Module
- 2.11** Electronics Compartment
- 2.11** Back Panel
- 2.13** Safety Features in the Pinnacle PCX
- 2.14** Standard Configurations of Pinnacle PCX

Introduction

This chapter is designed to familiarize you with the components, layout, and function of the Pinnacle PCX. Here you will find descriptions of each key component of the instrument and what it does.

At the most basic level, the Pinnacle PCX performs three main tasks:

1. Regulates the temperature of the analytical column
2. Delivers the reagent
3. Heats the reaction

In addition to accomplishing the above three tasks, the Pinnacle PCX has various features to make the analysis more reliable, convenient, and simple. It also contains features to protect the instrument from accidental damage.

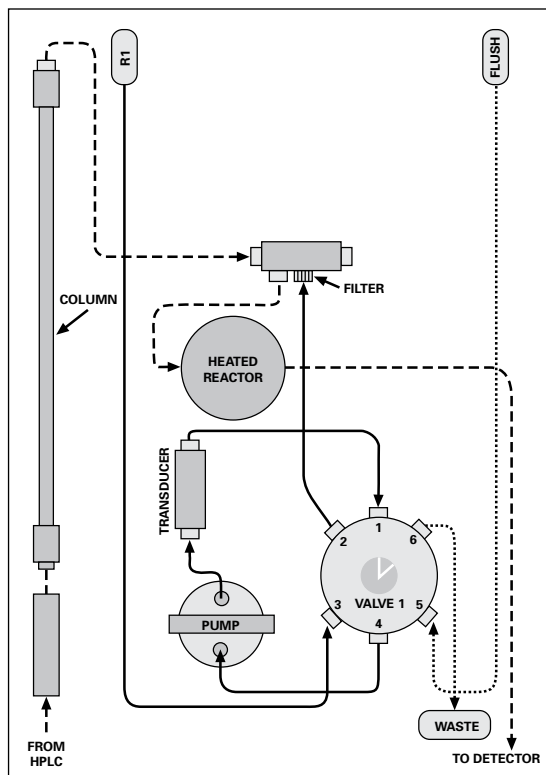

Flow Path - Single Pump

Figure 2-1

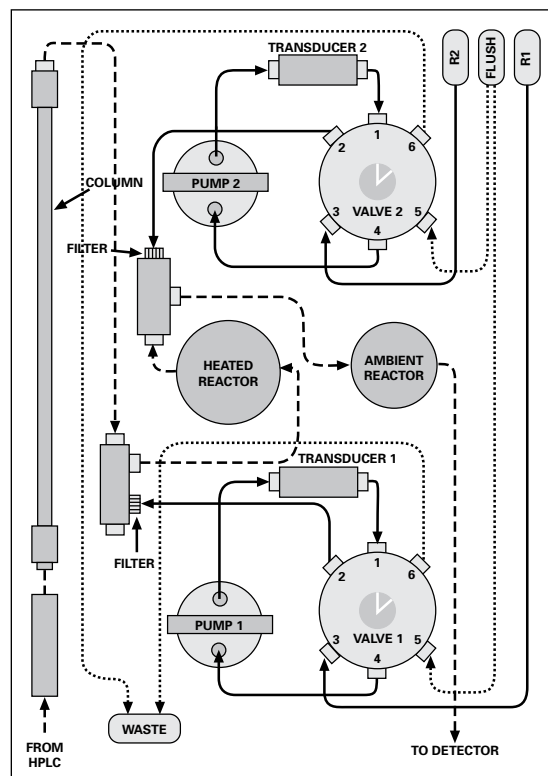

Flow Path - Dual Pump

Figure 2-2

The flow path of the Pinnacle PCX is extremely inert, rendering it very versatile. The same instrument can be used for many different applications, and will tolerate a high percentage of reagents.

Check Valve

The column check valve is located just outside of the column oven (figure 2-3). The check valve is designed to protect the column against backflow of the reagents in case of unexpected HPLC shutdown.

Column Connections and Column Oven

The column oven contains the analytical column and guard column (figure 2-3). The oven is a convection air oven. The column heater utilizes re-circulating air flow technology to provide quick, uniform column heating. Fast column cooling is assisted by the introduction of fresh air flow into the chamber by means of two fans that are controlled by the Pinnacle PCX control software. The temperature range holds within $\pm 1^\circ\text{C}$ resolution from 5°C above ambient to 75°C . A temperature gradient can be performed on the column to effect an increase in the speed of the separation. The temperatures can be programmed for a gradient with as many steps as required for fine-tuning an analysis.

The heater block is designed to receive the analytical column (5, 10, 15, and 25 cm long) and the guard column when they are connected via a column easy-connect fitting (included with the instrument, and sold separately by Pickering, Cat. #3102-3064).

The outlet end of the column hangs in the slot at the top of the column oven. The inlet to the guard column is at the bottom of the column oven door.

The column oven door contains a pocket to fit around the analytical column and guard. There is a groove in the door that is lined with Santoprene foam rubber cord that seals the door to the chassis and provides a stable insulated heating environment.

The last part of the lead-in capillary is located inside the column oven to preheat the eluant for a more uniform temperature within the column.

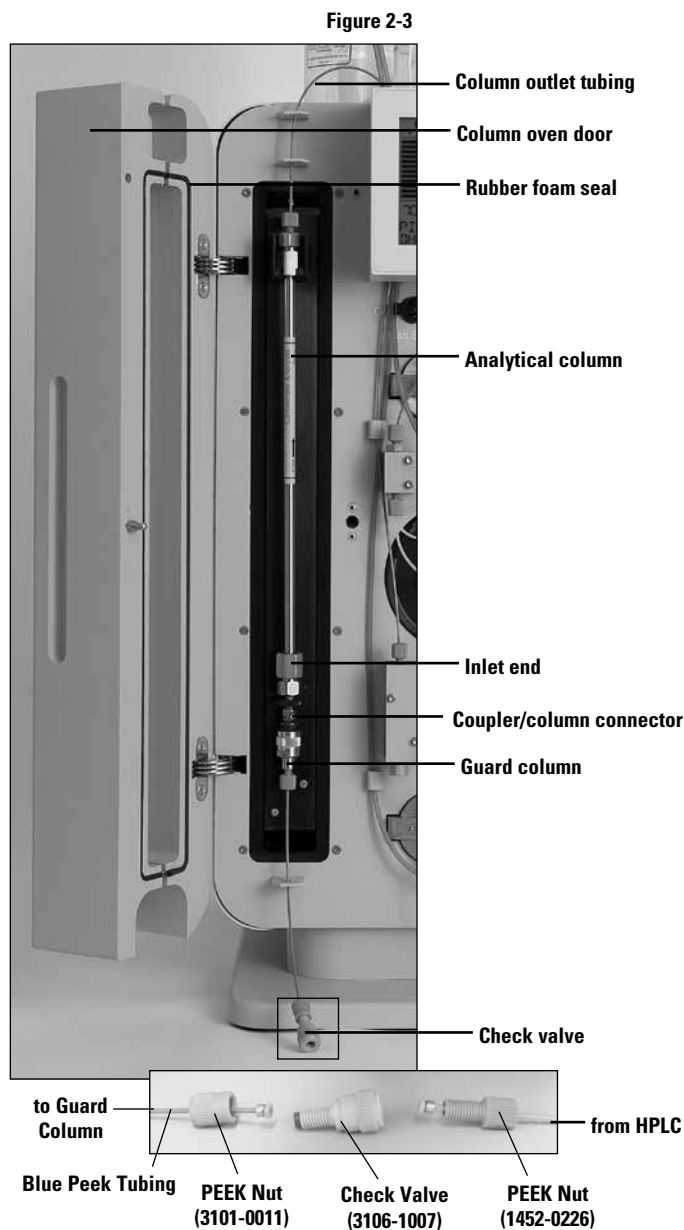

Make sure that the column door is securely closed before starting operation.

Warning. The column heating block may become hotter than 75°C. For your safety, wear insulating gloves when the column oven is warm.

Attention. La résistance chauffante de la colonne peut dépasser une température de 75°C. Pour votre sécurité, prière de porter des gants isolants lorsque le four de la colonne est chaud.

Warnung! Der Heizblock des Säulenofens könnte heißer als 75°C werden. Für Ihre Sicherheit sollten Sie isolierende Handschuhe tragen, wenn der Säulenofen warm ist.

Atención. El bloque calefactor de columnas puede estar por encima de 75°C. Para su seguridad use guantes aislantes cuando el horno de columnas esté caliente.

Avvertimento. Il blocco della colonna potrà diventare molto caldo e superare ai 75°C. Per la sua protezione usa guanti con insulazione per questa applicazione.

Reagent Pump

The reagent pump is a syringe pump. Refer to figure 2-4 and 2-8 (items 4 and 10). The syringe has a volume of 70 ml. The flow rate can be programmed from 0.05 ml/min to 1.5 ml/min. Once programmed, the syringe pump delivers at a constant speed. Since there is no need for constant refilling and dispensing (as with a reciprocating pump), there is a very high flow precision that does not require external pulse dampening features.

The syringe pump cylinder and head is made from a single piece of 99.9% Alumina for ruggedness and non-reactivity. The piston surface is made from PEEK with an inert o-ring seal.

The pump contains a piston wash for extended seal life. The piston wash is automatically performed with the movement of the piston.

For purposes of fast refill and flushing, the pump can refill or dispense (to waste) at 55 ml/min.



Figure 2-4

Reagent Valves

Reagent Valves are placed immediately after the pump. The valves have 5 possible operating positions:

- 1) **REAGENT:** From Reagent Bottle to Pump (3-4)
- 2) **REACTOR:** From Pump to Reactor (1-2)
- 3) **WASTE:** From Pump to Waste (1-6)
- 4) **FLUSH:** From Flush Bottle to Pump (5-4)
- 5) **BLOCKED:** The valve ports are blocked.

The valves are connected to a Flush Bottle which can be used to flush the reactor in the event of a shutdown or to aid in flushing the system. This will reduce the likelihood that the reactor becomes blocked. The valves are also connected to the reagent bottles and are used for filling the syringe pump.

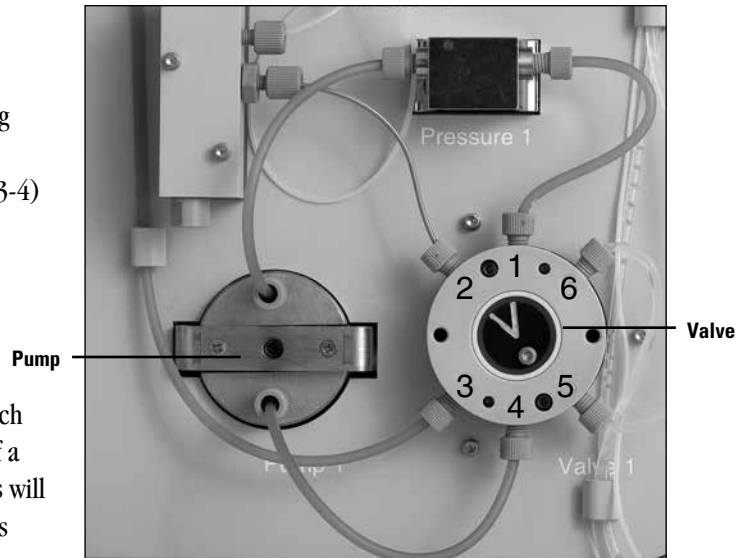

Figure 2-5

Reservoir Tray / Bottles

This is the tray located on top of the instrument. It holds the reagent bottles, wash bottle and flush bottle. It is removable for cleaning. It will hold 1L of liquid and as such is considered secondary containment. It does not seal any openings at the top of the instrument in case of heavy spillage.

There are 4 bottles located here:

1. Reagent Reservoir 1
2. Reagent Reservoir 2
3. Flush Bottle – contains water or 80-20 water/alcohol (IPA or Methanol) for flushing the instrument.
4. Piston Wash bottle – contains 90-10 water/alcohol (IPA or Methanol). This bottle is connected via 1/4 inch OD flexible tubing to the piston wash of each pump in the instrument. Change Wash and Flush solutions at least once a week to prevent contamination.

The pressurized reagent reservoir serves two purposes: It protects air-sensitive reagents from oxidation. It helps the syringe pump fill consistently and quickly by providing a source of pressure.

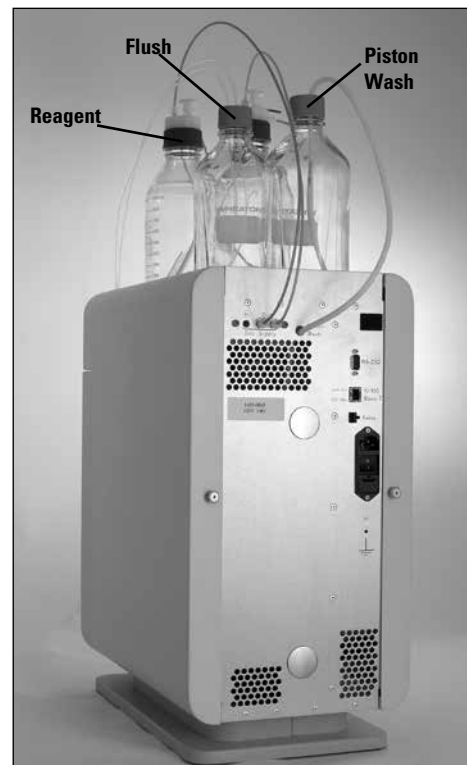

Figure 2-6

Reagent tubing is pre-connected to the pump at the factory. All Reagents lines are Air Barrier tubing. Reagent 1 is labeled R1, and Reagent 2 is labeled R2 throughout the instrument. Nuts and ferrules (1/4-28) are provided for connecting the tubing to the Reservoir caps.

The reservoir cap (Figure 2-7A) has two connecting ports on the top – one for connecting reagent line and one for connecting the gas line. The port for the gas line has a one-way valve to prevent backflow of the reagent into the gas manifold in case of a drop in gas pressure. Use nuts and ferrules (1/4-28) to make the connections. There are two stopcocks, one is for the vent port and the other is for the reagent line. Keep reagent line stopcock open for operation. Open the vent stopcock to sparge the reagent and close it to pressurize the reservoir. This is the normal operating position.

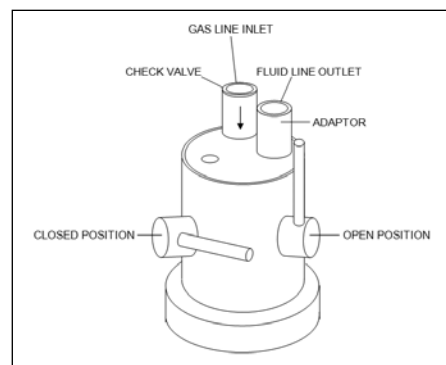

Figure 2-7A

When changing reagent, first turn off the gas using the toggle valve on the fluidics panel. Then vent the reagent bottle by opening vent stopcock. Now you can safely remove the cap. It is convenient to have extra bottles so that you can simply transfer the cap without setting it down and risking contamination.

If you have a reservoir cap shown on figure 2-7B, the large white knob is the valve; pull it up for CLOSED, and push it down for OPEN. If the gas is turned on, opening the vent valve will sparge the reagent. Closing the valve will pressurize the reservoir; this is the normal operating position. On the side of the cap, away from the on-off valve, there is a 1/4-28 fitting; you may optionally connect a tube here to carry vapors to an exhaust vent.

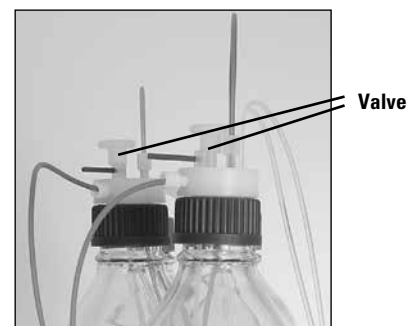

Figure 2-7B

Warning. For your safety, the bottles are coated with a tough plastic film and are rated to a maximum of 15 psig (1 bar). Do not use uncoated bottles.

Attention. Pour votre sécurité, les bouteilles sont recouvertes d'un film de plastique dur, et sont calibrées à un maximum de 10 psig (0.7 bar). Ne pas utiliser les bouteilles non recouvertes.

Warnung! Für Ihre Sicherheit wurden die Reagenzienflaschen mit einem festen Schutzüberzug aus Kunststoff versehen. Die Flaschen sind bis max. 0.7 bar (10 psig) zugelassen. Flaschen mit beschädigtem Schutzüberzug dürfen nicht mehr benutzt werden. Verwenden Sie keine Flaschen ohne Schutzüberzug!

Atención. Para su seguridad, las botellas están recubiertas con una resistente película plástica, y están constrastadas a 10 psig (0.7 bar). No utilice botellas sin recubrimiento.

Avvertimento. Per la sua protezione, le bottiglie sono costruite forti con un percentuale di plastica, e sono usabili per un massimo di 0.7 Bar (10 psi). Non usare bottiglie normali.

There are three types of Reservoir/Cap assemblies used on the Pinnacle PCX:

- 1) Reagent Reservoir is 1L, 45-430, safety-coated. These are shipped with blue caps with white valve assembly. These can be pressurized.
- 2) The wash Reservoir is 1L, 38-430, clear glass. These are shipped with caps with 1ea 1/4" opening and 2ea 1/8" openings. *These bottles cannot be pressurized, and do not contain threads for tubing connections.*
- 3) The flush Reservoir is 1L, 38-430, clear glass. These are also shipped with caps, but with 3 each 1/8" openings. *These bottles cannot be pressurized, and do not contain threads for tubing connections.*

Note: The two types of caps cannot be interchanged because the necks of the bottles are different sizes.

Fluidics Panel

The fluidics panel is the busiest area of the instrument. Everything that you will need is located on the front of the panel. The door can be removed if desired by the user for easy-access. Refer to figure 2-8 for parts identification throughout the next section.

Starting at the valves, the parts of the Fluidics Panel are numbered counter-clockwise.

1. Valve 2 (on dual systems only)
2. Pressure Transducer 2 (on dual systems only)
3. Gas is controlled by the toggle valve. Lever ON pressurizes the manifold.
4. Pump 2 (on dual systems only)
5. Column Outlet
6. Mixing Manifold 2 (with integrated reagent filter) (on dual systems only)
7. Heated Reactor
8. Mixing Manifold 1 (with integrated reagent filter and over-pressure relief valve)
9. Over pressure Relief valve
10. Pump 1
11. Pressure Transducer 1
12. Valve 1
13. Ambient reactor (on dual systems only)
14. Reactor outlet and union to connect to detector

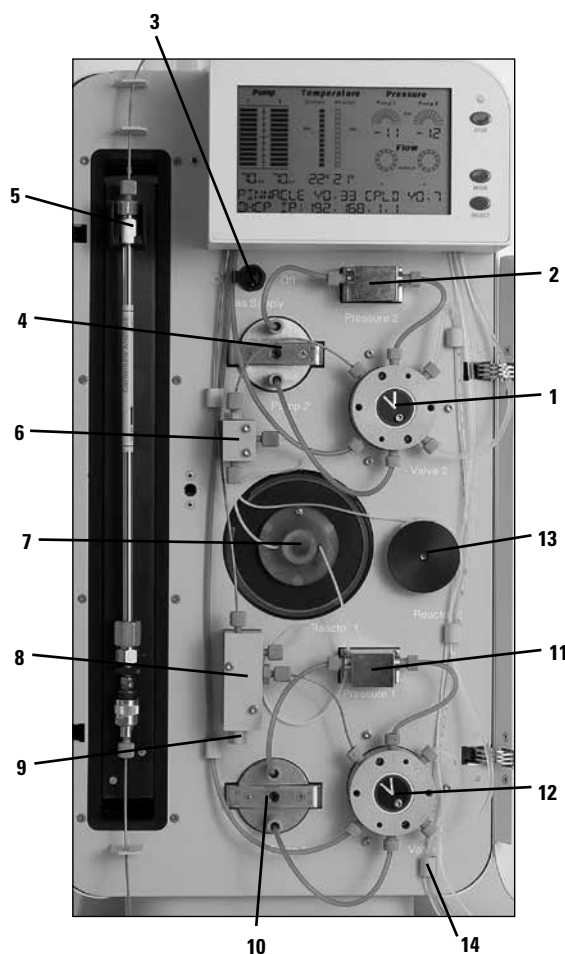

Figure 2-8

Quick Change Reactor

The standard reactor is a PTFE capillary tube 0.011" I.D. wrapped on a heated mandrel. The narrow diameter reduces band-spreading, and the PTFE is corrosion resistant. The reactor can be easily switched if it becomes blocked or if a different volume is required. The electronics of the reactor are contained within the Pinnacle PCX, making replacement affordable and easy.

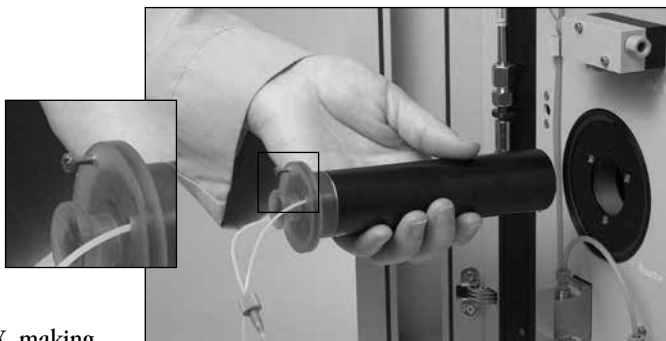

Figure 2-9

Volumes ranging from 0.15 ml to 3 ml are available. The most commonly used volumes are available off the shelf, but if you require a volume that is not in our price list, we can make it for you.

There is a 500 psi relief valve in case there is a blockage in the reactor or detector (Item 9 on Fluids Panel).

Detector Connections

There is a 100 psi (5 bar) back-pressure regulator (cat. # 3102-9025) on the exit line from the detector; it suppresses boiling inside the hot reactor and prevents bubbles from forming in the detector flow cell. This in turn provides for a smooth baseline and therefore high-sensitivity.

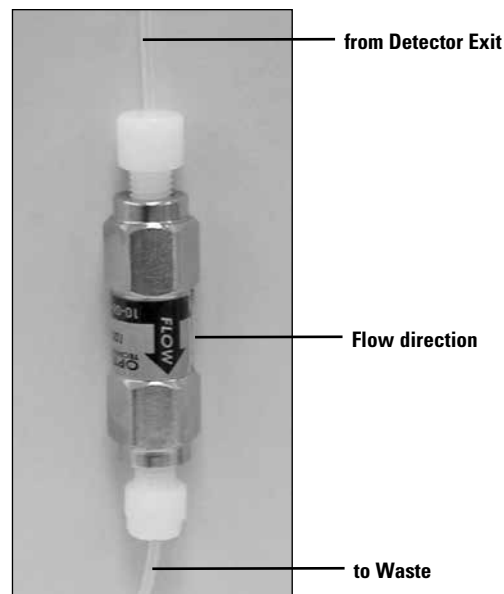

Figure 2-10

Pump Compartment

This compartment is located on the right side of the Pinnacle PCX. It contains the reagent pump(s), gas manifold, and electronics for the heated reactor and valves (figure 2-11).

The only time you will need to access this panel is for pump piston seal replacement. All other times, qualified personnel should make any repairs.

The Pump, Valves, and Heated Reactor are described in other sections.

Here you will see the Piston Wash feature for the reagent pumps. The Piston wash is a 1/4" OD tubing connected to the back chamber of the syringe.

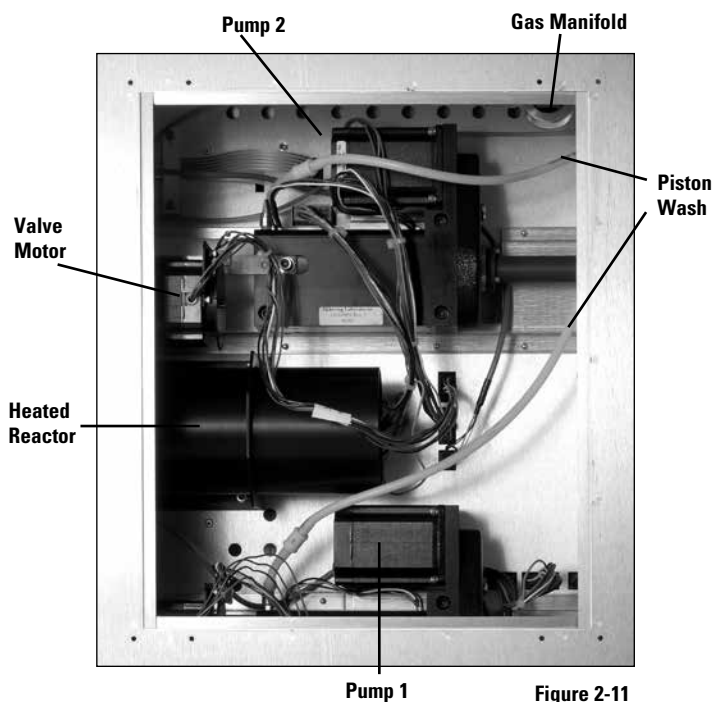

Figure 2-11

Gas Manifold

The "Gas Inlet" fitting is a 1/4-28 fitting located on the back panel of the Pinnacle PCX (reference fig 2-15). The inert gas source is connected via a 1/8" OD Air Barrier tubing, and the pressure is regulated to 5psi before pressurizing the reagent reservoirs.

The gas regulator requires an input pressure of 45–75 psi (3–5 bar) to function properly. The manifold has a safety relief valve that opens at about 10 psi to prevent dangerous over-pressurizing of the reagent reservoirs.



Figure 2-12

Display Module

The display module (figure 2-13) is the information panel of the Pinnacle PCX.

It displays:

the flow rate of each pump, the set point and current temperatures of the column and reactor the Pump pressure(s), which are also indicators of the pressure inside the post-column system and status information.

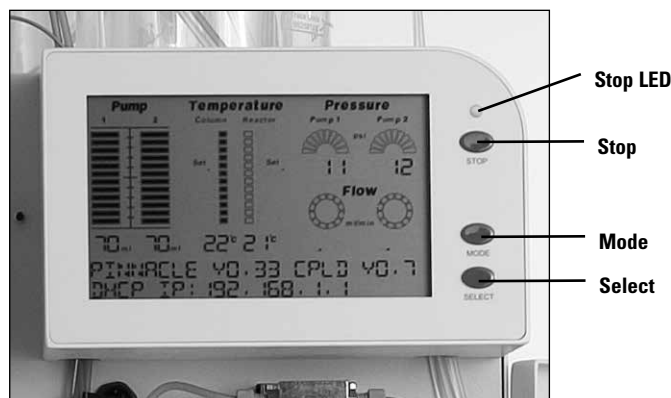

Figure 2-13

In addition to the electronic information on the LCD, the display module contains 3 buttons and one LED.

STOP - this button is used for an instant stoppage of the instrument in the case of an emergency. If this button is pushed, the instrument will cease all activity, regardless of what is happening.

The STOP LED will illuminate when the Pinnacle PCX has been stopped manually by the user. When STOP is pressed, the LED will glow red, indicating that there has been an emergency manual stoppage. To reset the instrument after emergency stop, turn instrument OFF and then turn it back ON.

MODE - Used during initial installation to determine the IP address. This function is for instruments that are connected to a company network.

SELECT - Used during initial installation to determine the IP address. This function is for instruments that are connected to a company network.

Electronics Compartment

This compartment contains the central nervous system of the Pinnacle PCX – the main PC board. From here, all communication is coordinated.

This compartment is separate from the pump compartment for two reasons:

- 1) To segregate the liquid end from the electronic end to avoid any damage to the PC board by reagents and liquids
- 2) To keep the board cool from the warm action chamber of the pumps

This compartment also contains:

- Power supply
- Cooling fans
- Column oven cooling mechanism

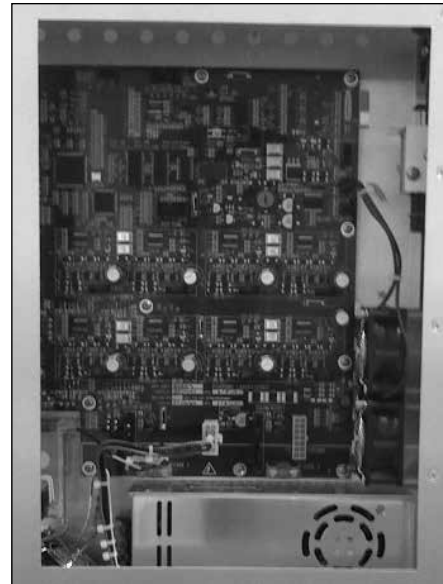

Figure 2-14

Since this compartment is very sensitive to liquids, and shocks, it is strongly recommended that no repairs are attempted by the user.

If there is a need for the user to open this panel, please do so only under the recommendation/instruction of qualified Pickering support personnel.

Back Panel

- This panel contains:
- Communication Ports
 - Gas Inlet
 - Power
 - Fuses
 - Vents and other openings

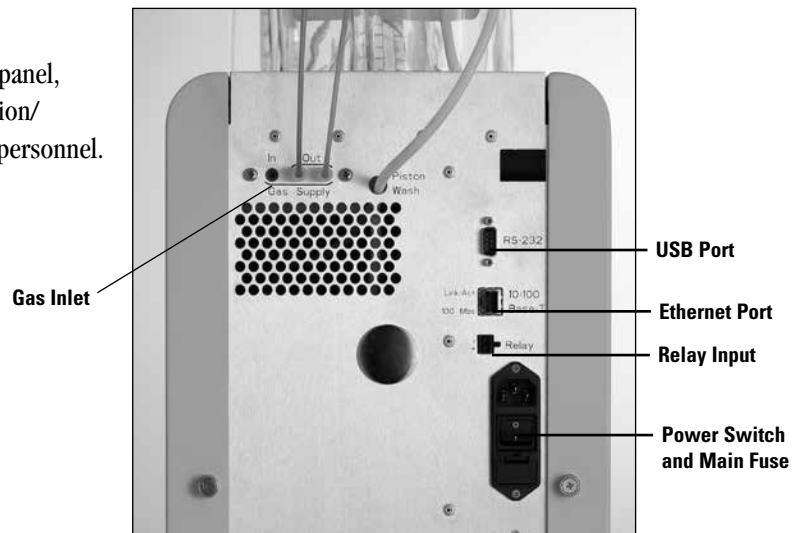

Figure 2-15

COMMUNICATION PORTS

USB Port

The USB port on the Pinnacle PCX connects directly to one of the USB ports on the computer.

Relay Ports

The relays will be explained in the operations chapter under Site Requirements.

Ethernet Port

This port is used for connecting the Pinnacle PCX to a network.

POWER SWITCH AND MAIN FUSE

The power connector is a standard IEC 320 type connector. Use the appropriate power cord for your local wall outlet and electrical code.

The 120V version comes with a standard North American cord set.

The 240V version comes with a cord set used in much of continental Europe.

Your local reseller may have provided the correct local cord set. If your local power outlets are different, you will need to obtain the appropriate grounded cord set.

The main power switch is located in the power connector assembly.

The fuse holder is located in the power connector assembly. To change the fuse, first remove the power cord from the connector. Carefully pry out the fuse clip with a small screwdriver. Replace with the specified-type fuse: 2 ea, 5mm x 20 mm, 6 A, time lag.

Warning. Ensure that the power cord is disconnected before replacing a fuse. Use only the specified-type fuse.

Attention. Assurez vous que le cable secteur n'est pas connecté avant de changer un fusible.

Warnung. Sicherungen dürfen nur bei nicht angeschlossenem Netzkabel ersetzt oder gewechselt werden.

Cuidado. Asegúrese que el cable de red está desconectado antes de instalar o cambiar un fusible.

Attenzione. Assicuratevi che il cavo di alimentazione sia scollegato prima di installare o sostituire un fusibile.

Waarschuwing. Zorg dat de voedingskabel losgekoppeld is, voordat een zekering wordt geplaatst of vervangen.

Avvertimento. Fare attenzione che la corda del voltaggio sia staccata prima di cambiare valvole. Usa solo valvole di capacità precisata dalla fattoria.

Safety Features in the Pinnacle PCX

The Pinnacle PCX system has features designed into the instrument and operation that will prevent reagent back-flow onto the column and bursting of reactor tubing due to a blockage.

Post-column reagent can immediately damage the analytical column if the reagent flow is diverted in the wrong direction by a lack of HPLC flow.

This is prevented by:

1) In-line Check Valve

A one-way check valve placed before the column prevents the flow of liquid in the direction of the column.

2) Over-pressure Relief Valve

In the rare event there is a blockage in the post-column system, an integrated 500 psi over-pressure relief valve will open and divert the liquid into the drip tray. This will prevent a bursting of tubing or fittings. By relieving the pressure, this will give you the opportunity to correct the blockage rather than having to replace the heated reactor.

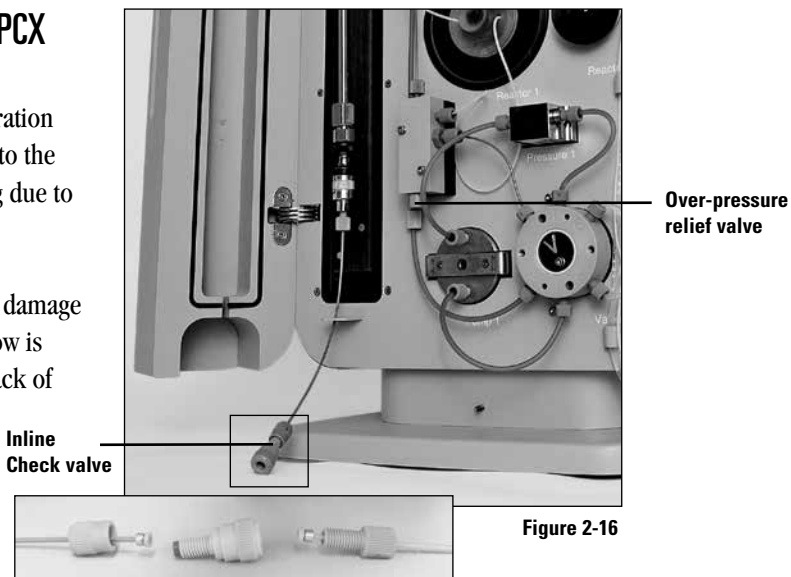
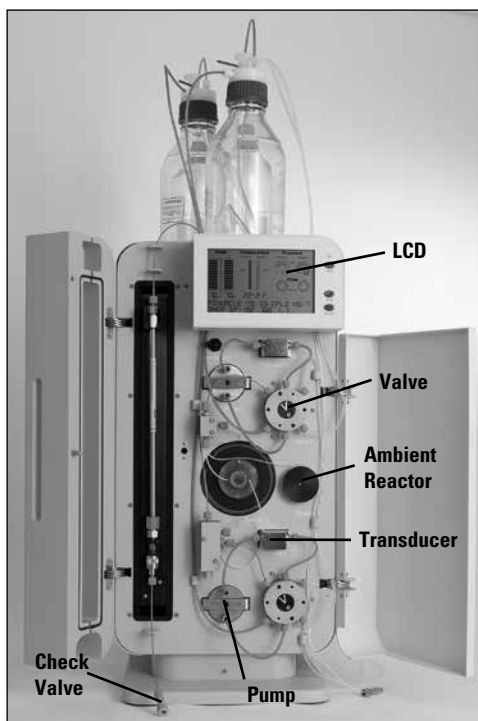

Figure 2-16

Standard Configurations of Pinnacle PCX

The Pinnacle PCX is available in standard configurations for one-reagent or two-reagents, standard or micro volume, 120V or 240V operation, and is shipped completely assembled, calibrated, and tested. Custom instruments are also available; contact Pickering Laboratories for a quote.



Dual Reagent System

Figure 2-17

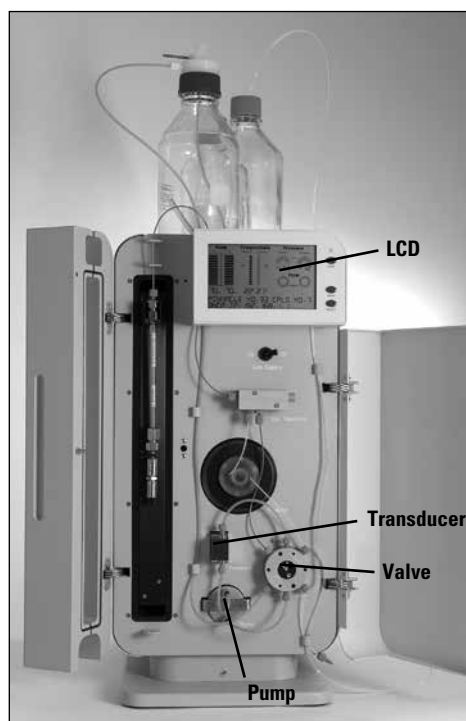

Single Reagent System

Figure 2-18

The one-reagent instrument consists of a single reagent pump, valve, heated reactor, column heater, backflow and over-pressure safety devices, filters, reagent reservoir, gas manifold, Air Barrier gas tubing, and other accessories.

The two-reagent Pinnacle PCX contains two reagent pumps, two valves, heated and ambient reactors, column heater, backflow and over-pressure safety devices, filters, reagent reservoirs, gas manifold, Air Barrier gas tubing, and other accessories.

The Pinnacle PCX includes one pressurized reagent reservoir for the one-reagent system and two for the two-reagent system.

The instrument also includes a 1L wash bottle and a 1L flush bottle for the piston wash and flush feature.

Section 3

INSTALLATION

- 3.2** Site Requirements
 - 3.4** Instrument Unpacking and Preparation
 - 3.5** Gas Connections to Back Panel of Pinnacle PCX
 - 3.6** Computer Connections
 - 3.6** Software Installation
 - 3.8** Pump and Autosampler Connections
 - 3.10** Eluant Priming
 - 3.10** Column and Guard Installation
 - 3.11** Detector Connections
 - 3.12** Reservoir Connections
 - 3.13** Reagent Pump Preparation
 - 3.14** Running a Chromatogram
 - 3.15** Shutdown
- Installation Checklists (see Appendix)

The Pinnacle PCX instrument is shipped in one carton. Application Kits may be shipped in one or more cartons each. Report any carton damage to the carrier. Unpack all cartons and review the contents using the Packing List to ensure that your order is complete. If any items are missing, immediately contact Pickering Laboratories at (650) 694-6700 or by fax at (650) 968-0749.

Store any standards in the freezer or refrigerate immediately upon arrival. Pickering Amino Acid, Carbamate, and Glyphosate columns are shipped with test mixtures. Remove the vials from the box and freeze upon arrival.

While installing the Pinnacle PCX complete the Installation Checklist located in the Appendix. When the installation is completed, fax or mail the checklist back to Pickering Laboratories and place in the front of the Operation Manual under the tab labeled Installation. If the customer requires it, complete the IQ/OQ procedure (also located in Appendix) and add that to the tab labeled Installation.

Read all installation instructions and material safety data sheets (MSDS's) before operating your post-column derivatization instrument and HPLC system.

Note: Before the Pinnacle PCX can be installed and qualified properly, the HPLC must be completely installed and in good working order (including pump, injector, detector and data collection system). The user prior to Pinnacle PCX installation must remove all organic compounds that are immiscible with the Pickering Laboratories' eluants as well as any hazardous chemicals.

The Pinnacle PCX uses three main styles of fittings.

1. Lite-touch fittings

These are 10-32 nut with 2-part ferrules for 1/16" OD tubing. These fittings are found at the column connections, and at the inlet to the reagent filters. (nut: 1452-0118, ferrule: 1452-0117)

2. Long PEEK fittings

These are 1/4-28 nuts with 2-part ferrules for 1/8" OD tubing. These fittings are found at the inlet and outlet of the reagent pumps. Low-pressure gas and reagent fittings are 1/4-28 x 1/8 inch size. (nut: 1452-0116, ferrule: 1452-0115)

3. Short PEEK fittings

These are 1/4-28 nuts with 2-part ferrules for 1/16" OD tubing or 1/8" OD tubing. These fittings are found at the connections to the electronic valves and transducers. (nut: 1452-0113, ferrule: 1452-0115)

Pickering Laboratories supplies all the matching nuts and ferrules needed for normal installation.

Site Requirements

PINNACLE PCX SITE REQUIREMENTS

The minimum bench top space required for the Pinnacle PCX system is approximately 32H x 16W x 20D inches (81 x 41 x 51 cm), both doors fully opened, with bottles and electrical connections in place. The Pinnacle PCX weighs approximately 67 lbs (30kg) for simplex systems, and approximately 77 lbs (35kg) for duplex systems. The minimum bench space does not include the HPLC system. The total space requirement depends on the brand and model of HPLC.

For most cases, it is best to place the LC pump and injector system on the left side of the Pinnacle PCX, and the detector on the right.

In addition to the power outlets required for the HPLC system, one grounded outlet will be needed.

Nitrogen is required to pressurize the reagent reservoir(s). The Pinnacle PCX requires gas pressure of 45-75 psi (3-5 bar) at the gas inlet. An adaptor from the gas regulator to 1/8 inch OD tubing is required. To minimize oxidation of the TRIONE® ninhydrin or OPA reagent, use oxygen-impermeable tubing for the entire gas supply line (Air Barrier or metal).

Note: If TRIONE® is to be used for Reagent 1, Nitrogen must be used to prevent out-gassing.

A waste container should be provided for the waste lines from the Pinnacle PCX and the HPLC detector.

HPLC SYSTEM REQUIREMENTS

Since every HPLC is different, the following procedure has been generalized. Before attempting to connect any tubing, examine the HPLC setup, and determine the best possible means of making the connections. Small ID tubing (0.011") should be used wherever the sample is in the flow path.

Important! If the system will be used for amino acids, glufosinate, glyphosate, polyamines, or diquat & paraquat analysis, be aware that the column regenerant is strongly alkaline. Any polymers or other materials in the HPLC pump, injector, needle seat, and detector must be compatible. For example, the standard rotor seal in Rheodyne injector valves is Vespel® polyimide, which is not recommended at pH >9; a Tefzel® or PEEK rotor seal must be installed.

For all applications, the pressure rating of the detector flow cell must be > 110 psi (7.5 bar)

FOR AMINO ACID ANALYSIS

Pump

Minimum ternary gradient elution
Piston wash capability is preferable

Injector

Tefzel or PEEK rotor seal for injector valve
Tefzel or PEEK needle seat if it is an autosampler

FOR GLYPHOSATE ANALYSIS

Pump

Minimum binary gradient elution
Piston wash capability is preferable

Injector

Tefzel or PEEK rotor seal for injector valve
Tefzel or PEEK needle seat if it is an autosampler
For water samples, at least 200 µl injection

FOR CARBAMATE ANALYSIS***Pump***

Minimum binary gradient elution

Injector

For water samples, at least 200µl injection

For all other applications, review the method notes for chemistry requirements.

HPLC RELAY REQUIREMENTS

For HPLC systems other than Agilent 1100, or 1200, the Software and system must be capable of sending a relay signal to an external piece of equipment to achieve synchronization.

Chemstation version 9.0 or higher is needed for Agilent 1100 or Agilent 1200. Pinnacle PCX software will communicate with Chemstation directly – no relay connection is needed.

Any machine that drives this relay input shall provide a relay contact pair that is electrically isolated from all other electrical devices. The relay signal must have:

Relay detection voltage	24 +/- 2 V
Relay detection current	Approximately 1 mA

COMPUTER REQUIREMENTS

For the Installation, we strongly recommend installing the USB cable.

Use of the network connection is optional at the user's discretion.

The computer must have:

Microsoft Windows XP, Vista, and Windows 7.

Minimum of one extra USB port for installation

Available Memory: Minimum 10Mb

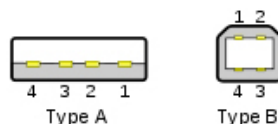
**Instrument Unpacking and Preparation****UNPACKING**

Unpack all cartons and review the contents using the Packing List to ensure that all of the items are present. If any items are missing, immediately contact Pickering Laboratories, Inc.

Toll Free: (800) 654-3330
International: (650) 694-6700
Email: support@pickeringlabs.com
Internet: www.pickeringlabs.com

Unpack the instrument and place it on the bench. Place it so there is enough clearance between the Pinnacle PCX and the HPLC, detector, and the edge of the bench.

Ensure that there is enough room to open the column oven door and the fluidics door.

Ensure that there is at least 3 inches clearance between the outlet vent at the back of the Pinnacle PCX and any walls or other instruments. This is very important for proper cooling of the column oven.

PREPARATION AND INSPECTION

Place the Pinnacle PCX on the bench.

Examine the external chassis for damage.

Open the column oven door. Check that it is straight. Check that the latch is tight and undamaged.

Open the Fluidics chamber door. Check that it is straight.

Examine the connections on the face of the fluidics panel. Check that there are no broken, bent, or loose tubings.

Remove the right side panel. Check that the pump/s is/are firmly attached to the chassis. Uncoil the 1/4" C-flex tubing. This tube is for the piston wash. Place the tubing on top of the instrument in the Reservoir tray.

Check that the piston wash tubing is firmly connected to the Y fitting, see figure 2-11.

Replace the right side panel.

Connect the power cord to the outlet in the back of the Pinnacle PCX, just above the power switch.

Gas Connections to Back Panel of Pinnacle PCX

Connect the Inlet Gas line to the back of the Pinnacle PCX.

[Set the regulator on the inert gas supply to between 45-75 psi] Using either 1/8" OD Air Barrier tubing, or 1/8" copper tubing, connect the gas supply to the Gas Inlet fitting on the back panel of the Pinnacle PCX with the 1/4-28-1/8" nuts and ferrules (PN 1452-0181 and 1452-0180).

Do not connect the 1/8" Air Barrier tubings to the bottles yet. Lay them carefully in the Reservoir tray. The gas connections will be completed later in the installation.

Carefully turn on the main gas supply. Switch the toggle valve to the ON position to start gas flow. Let the gas system purge for about one minute. Check for leaks at the Gas Inlet connection, and check that there is gas flowing out of the 1/8" tubes.

Switch the toggle valve OFF.

Slide the Pinnacle PCX into place on the bench. Allow a minimum of 3 inches of space for venting at the back of the instrument.

Computer Connections

RELAY CONNECTIONS

Relay Input Connector can be used to trigger Pinnacle PCX operations.

Connect the relay cable to the Relay Input Connector on the back of the Pinnacle PCX. The opposite end of the cable will be connected to the HPLC system's location for relay output. Refer to the HPLC operation manual for further information.

POWER-UP

Turn on the power switch, but do not operate the buttons.

Upon power-up, the valves will find their home positions. Ensure that this happens. Check that the LCD displays the status of the instrument.

Software Installation

Insert the CD into the computer and follow the on-screen instructions. The Installation wizard will guide you through the installation and configuration process.

MULTI INSTRUMENT SUPPORT

Select the number of Pinnacle PCXs that will be connected to the same PC. For each Pinnacle an icon will be created on the desktop. Configure each instrument separately.

COMMUNICATION METHOD

Select Network or USB cable. These settings can be modified later in the Configuration window of the Pinnacle PCX software.

SECURITY LEVEL

Select who can access the Pinnacle PCX program. “Everyone” will allow access to many users while “Just me” will only one user.

REGISTER

Complete the registration form and e-mail directly to support @pickeringlabs.com or print and fax to (650) 968 – 0749.

OPTIONAL***Connecting the Pinnacle PCX to the network***

It is at the user’s discretion if they would like their Pinnacle PCX placed on their company network. This will involve working closely with the Company’s IT personnel, to determine proper address and their network security procedures.

A network cable is provided with the Pinnacle PCX

Connector RJ45

Connection Speed 10/100-Base-T

Ethernet protocol TCP/IP

IP address User set or DHCP

DHCP IP address is assigned by a DHCP server. The network administrator must configure the DHCP server so that the same address is reserved for and always given to Pinnacle PCX.

User set or Static IP address is set in the Pinnacle PCX. The network administrator must provide an address specifically for Pinnacle PCX.

Note: We recommend connection to a Network Switch or Router, or direct connection to a dedicated Network card in the PC.

Setting up or Changing User set (Static) IP address Follow the chart below:

Note: Use the MODE button to go through options and the SELECT button to select the option. Messages appear at the bottom of the main LCD screen.

Turn Pinnacle PCX ON. While instrument is initializing press the STOP button and hold till the message reads:

BOOT: 1-04 CPLD: 2.5

DHCP IP: 192.168.111.111

Press MODE button. The message will read:

RUN MAIN F/W

DHCP IP: 192.168.111.111

Follow the chart below to make changes in IP address.

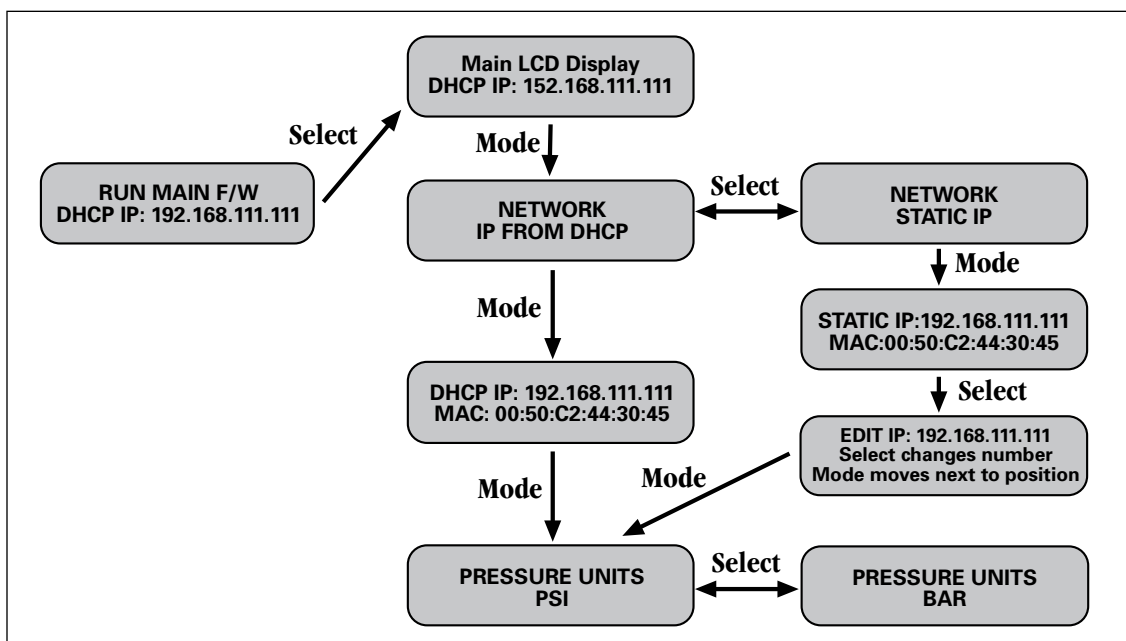

Restart the instrument after completing the steps above.

Pump and Autosampler Connections

Note: Do not fit the analytical column and guard yet.

Replace any mobile phase that is more than 2 weeks old, especially DI water. Rinse the reservoir bottles thoroughly with soap and water. Wipe down the dip tubes on the caps with methanol and a clean, lint-free cellulose tissue. Avoid touching the tubing or the interior of the reservoir with your skin and do not leave caps and lines dangling without a reservoir because this can cause contamination.

Fill reservoirs with 80/20 Water/Methanol

Open the prime-purge valve on the HPLC. Purge each line in the system with a water/methanol mixture to flush the system. Set the flow rate to the maximum and purge at least 25 ml through each line.

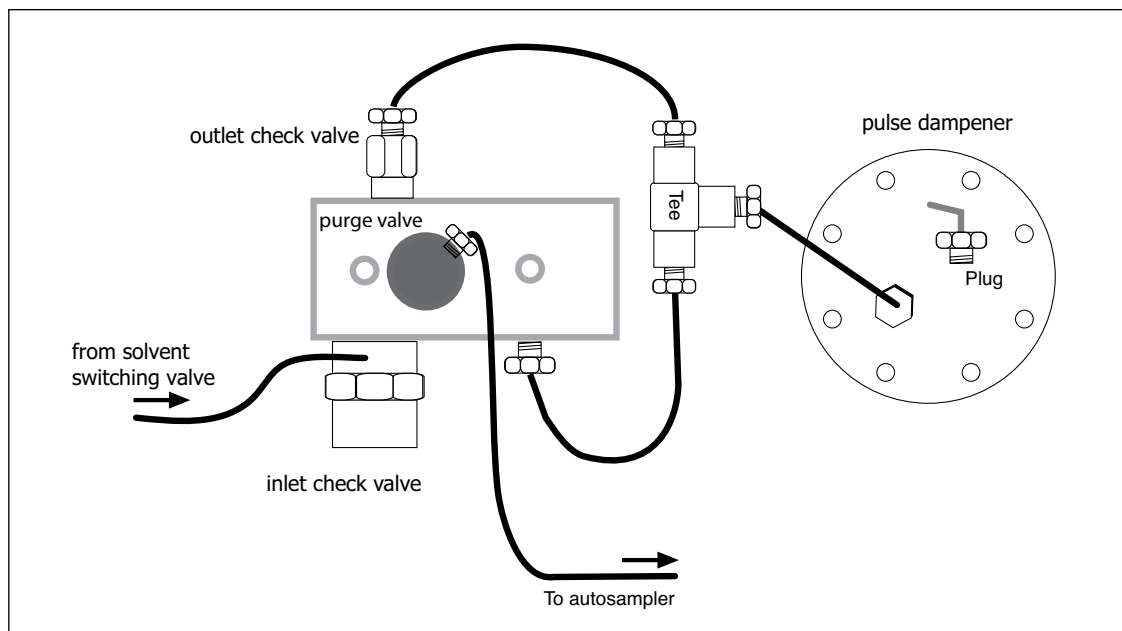

Figure 3-1

Drop the flow rate to 1 ml/min and close the prime-purge valve to flush the lines to the injector.

If this is an amino acid system, it is highly recommended that you dead-head the pulse dampener of the pump. This will provide reliable gradient formation, and will prevent corrosion of the low-grade steel used in most pulse dampeners.

Use one of the two methods below for making the connections. Amino Acid systems must be connected according to method 2.

1. Connect the outlet of the injector to the inlet of the pre-column check valve assembly.
- OR
2. Connect a tee to the inlet of the pulse dampener. Connect a line from the outlet of the pulse dampener to a tee and place a high-pressure plug in the outlet. Connect the inlet and outlet of the pump through the tee (figure 3-1).

Connect the outlet of the injector to the Check Valve assembly. Use 0.011" ID tubing and a PEEK nut and ferrule. (PNs 1452-0118, 1452-0117, 2104-0210, 1452-0226)

Place the open end of the check valve tubing into a beaker.

Flush line from injector for 5 minutes at 1 ml/min with 80/20 Water/Methanol.

Eluant Priming

Before proceeding, check for and repair any leaks between the pump and the pre-column check valve. Once you are certain there are no leaks, do not open the connections between the pump and injector.

IMPORTANT! If any application other than Carbamates is to be used, remove water/methanol and replace with water. Flush at least 10 ml through lines and flush injector line. This is to prevent any precipitation issues between Methanol and the buffers and to prevent any organic solvents from entering the column. Pickering Laboratories cation exchange columns for Amino Acids and Glyphosate analysis will be damaged by organic solvents.

Fill the reservoirs with the appropriate eluants/mobile phases and again flush at least 25 ml OF EACH ELUANT with the purge valve in the open position.

Close the purge valve, and pump each eluant at 2 ml/min for 5 minutes.

If buffers will be used as the eluant, use pH paper to measure the pH of the solution coming through the tubing.

Column and Guard Installation

Set the HPLC to 100% of the storage solution in the column.

Install the pre-column check valve and female nut inline before the column over door. Reference the Flow Diagram in section 8.5 for complete parts list of the pre-column check valve.

Start the flow rate to 0.2 ml/min.

Connect the line from the outlet of the pre-column check valve to the inlet of the guard column.

When liquid exits the guard column, connect the “column connector/coupler” provided in the packing kit. When liquid exits the connector, connect the

Figure 3-2

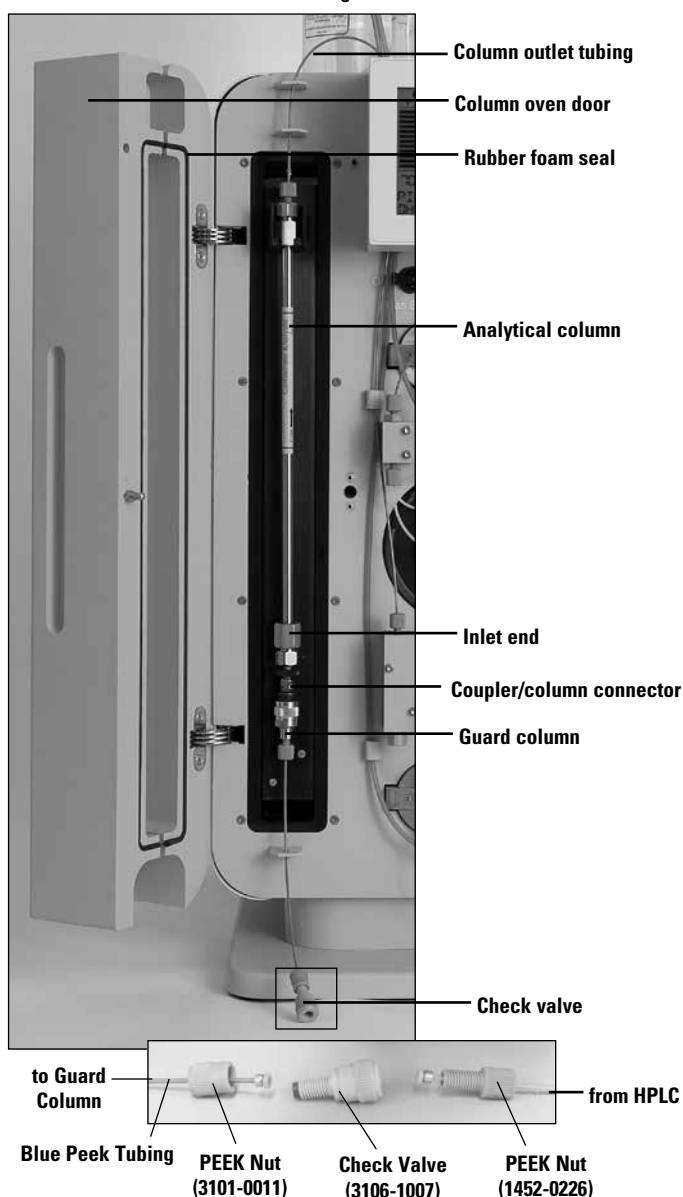

analytical column. Connect the Column Outlet tubing (pre-formed and cut to the right length at Pickering). Hang the column in the column oven, use care to ensure the tubing passes through the guide hooks at the top of the column oven. The guard column should be at the bottom, and the exit of the column at the top.

NOTE: If the application is one that uses sodium or lithium buffers, use deionized water to clean any stainless steel fittings that have come into contact with buffer to prevent corrosion.

Monitor the pressures and stop the HPLC pump when the pressure stabilizes.

Detector Connections

Connect a 1/16 inch x 0.020" ID tubing from the outlet of the Detector to the external 100psi back-pressure regulator (PN 3102-9025) using a 1/4-28 nut with a 1/16 inch reversed-ferrule. There is an arrow on the back pressure regulator indicating direction of flow. Insure that the arrow is pointing away from the detector and toward the waste line.

Connect the 0.020" ID PTFE tubing provided in the packing kit (PN 2101-0225) to the outlet of the external 100 psi back-pressure regulator. Place the other end in an appropriately labeled waste container.

Connect the PEEK union to the outlet of the Ambient reactor (or Heated reactor if it is a single-pump system) using a Lite-touch Nut and Ferrule.

Connect a 0.011" ID tubing from the outlet of the union at the exit of the fluidics panel on the right-hand side of the instrument to the inlet of the detector flow cell.

Set the time constant on the detector to 2–4 seconds.

The pressure rating of the detector flowcell must be >110 psi (7.5 bar). If your detector flowcell is rated lower, consult Pickering Laboratories.

Special Note to Hewlett-Packard 1046A end-users: Replace the 0.12 mm ID inlet tubing (red) and heat-exchanger from the left side of the detector to the flowcell (behind the front panel of the detector) with a 0.25 mm ID (blue) tubing (HP Cat. No. 79881-67302) to reduce the back-pressure.

Caution! The 100psi back-pressure regulator is directional. Do not reverse flow!

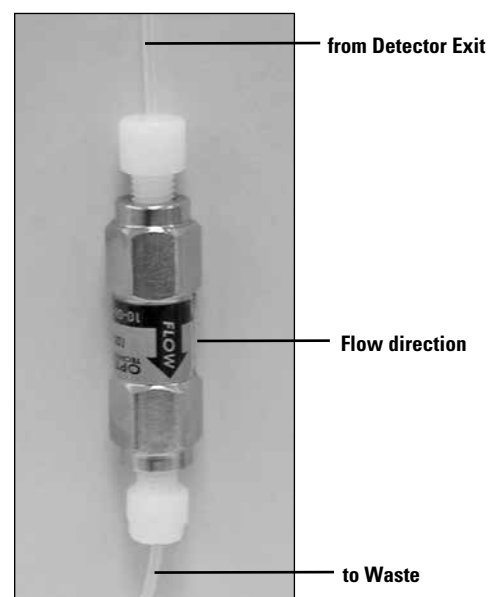

Figure 3-3

Reservoir Connections

Wash all of the Pickering Pinnacle PCX reservoirs with laboratory detergent and hot water.

Rinse with methanol then with deionized water.

Wipe down the dip tubes on the caps with methanol and a clean, lint-free cellulose tissue. Avoid touching the tubing or the interior of the reservoir with your skin and do not leave caps and lines dangling without a reservoir because this can cause contamination.

There are three types of Reservoir/Cap assemblies used on the Pinnacle PCX:

Reagent Reservoirs are 1L, 45-430, safety-coated. These are shipped with blue caps with white valve assembly. These can be pressurized.

Wash Reservoir are 1L, 38-430, clear glass. These are shipped with blue caps with 1ea 1/4" opening and 2ea 1/8" openings. *These bottles cannot be pressurized, and do not contain threads for tubing connections.* Flush Reservoir, is 1L, 38-430, clear glass, from Wheaton. These are also shipped with caps, but with 3ea 1/8" openings. *These bottles cannot be pressurized, and do not contain threads for tubing connections.*

The two types of caps cannot be interchanged because the necks of the bottles are different sizes.

REAGENT RESERVOIR CONNECTIONS

Connect 1/8" Air Barrier lines from "Gas Supply OUT" port on the back of the Pinnacle PCX to the CHECK VALVE on the top of the reagent cap. Use a 1/4-28 Nut and ferrule (PN 3101-0005 and 3101-0006). Don't over tighten!

Connect 1/8" Air Barrier lines from the Reagent ports of the valves (No 3) ports at the front of the Pinnacle PCX to the empty port on the top of the reagent cap. Use a 1/4-28 Nut and ferrule (PN 3101-0005 and 3101-0006). Don't over tighten!

Put the cap on the bottle.

Toggle the Gas switch to ON and check that gas is flowing through the reagent cap. Close the stopcock under the vent hole to pressurize the bottle. Open the stopcock under the reagent line before refilling the pump.

Caution! The reagent bottles are specially coated with a protective polymer to ensure operator safety if the reservoirs should become over-pressurized. Non-coated bottles must not be substituted in the Pinnacle PCX system. Replacement 1 L, 2 L, or 5 L reagent bottles may be ordered directly from Pickering Laboratories.

Reservoirs should be labeled with an appropriate label using the GLP of the laboratory.
Fill the Flush reservoir with water or 80-20 water/alcohol (IPA or Methanol)
Fill the Wash reservoir with 90-10 water/alcohol (IPA or Methanol).
Change Wash and Flush solutions at least once a week to prevent contamination.

Rinse the Reagent reservoir(s) with a small amount of reagent or diluent, and then if necessary prepare the post-column reagents as described in the appropriate Application section of this manual.

FLUSH RESERVOIR CONNECTIONS

Take the 1/8" FEP tubes leading from the Flush (No. 5) position on the valves and slide the tubing through the 1/8" openings on the proper cap. This will be a snug fit to prevent slipping.

(PISTON) WASH RESERVOIR CONNECTIONS

Take the 1/4" C-flex tubing leading from the piston wash of the reagent pump(s) and slide it through the 1/4" opening in the proper cap. This will be a snug fit to prevent slipping.

Reagent Pump Preparation

All of the reservoirs should now be filled with the appropriate solutions.
Ensure that the Flush and Piston Wash lines are immersed in liquid.

The Pinnacle PCX has a maximum of two waste lines that must be fed into a waste container. They can either be fed into a separate container, or into the waste stream of the HPLC. These are the 1/8" OD clear FEP tubes that are connected to the Waste port (No. 6) on the valves.

Dual pump systems will have two lines, and single pump systems will have one.

In the Pinnacle PCX software, select **Empty pump(s)** under the Control menu. Select **Both pumps** for 2-pump system. The valve(s) will move to waste (1-6) position and pump(s) will dispense all the liquid.

In the Pinnacle PCX software, select **Flush pump(s)** under the Control menu. Select **Both pumps** for 2-pump system. The system will flush pumps using Flush solution. The pump(s) will be empty at the end of Flush cycle.

Running a Chromatogram

Look in the column box for the gradient program and conditions.

Set the HPLC pump to run the starting eluant conditions, and while the system is equilibrating, set up the gradient method in the HPLC software. We recommend that equilibration is set up at the end of each run (as a post-run, if possible). Equilibration time should be at least 5 min long to give Pinnacle PCX enough time to refill between the runs. If using relays to synchronize with Pinnacle PCX set up relay signal at time 0.0 in the HPLC method. Contact your HPLC support representative if you have questions about setting up relay signal.

Create a sequence for the HPLC system.

Set up method and sequence for Pinnacle PCX (refer to section 4 OPERATION of this manual). Load the sequence. Make sure correct sequence name and method name are displayed in the status bar at the bottom of the Pinnacle software (If sequence and method fail to load: close Pinnacle PCX software, reopen Pinnacle PCX software, reload sequence and method).

In the Pinnacle PCX software, select **Enable** in the **Control menu**. Column and reactor heater will be turned ON. Wait for temperatures to reach the set point.

Select **Refill pump(s)** in the **Control menu**. Select **Both pumps** for 2-pump system. The valve(s) will move to reagent (3-4) position and the pump(s) will refill enough reagent for one run.

NOTE: Pinnacle software will calculate needed reagent volume based on your run time and reagent flow rate. Some extra volume will be added to that to ensure pumps will not run out of reagent during operation.

Select **Pump(s) ON** in the **Control menu**. Select **Both pump(s)** for 2-pump system. The valve(s) will move to reactor (1-2) position and pump(s) will start dispensing reagent at set flow rate. Wait until the pressures are stable.

Select **Sequence – Start Sequence**. Run time (0.0) will be displayed in the Status Bar at the bottom of the Pinnacle PCX software. The reagent pump(s) will start dispensing reagent. Pinnacle now waits for injection signal from HPLC in order to start running the method.

For TRIONE® Amino Acid Analysis:

Set the detector wavelength(s) to 570 and 440nm (if applicable).

Do four runs of the Amino Acid Standard that was provided with the chemical kit. Inject 10 μ l.
Discard the first injection.
Compare the chromatogram with that of the QC test of the system and column.
Verify that the system is functioning by using the IQ/OQ documents as reference (See Operation Manual, Appendix)

For Carbamate and Glyphosate Analyses:

Set the detector excitation wavelength to 330 nm and the emission wavelength to 465 nm
Do at least four runs of the appropriate test mixture. Inject 10 μ l.
Discard the results of the first injection.
Compare the chromatogram with that of the QC test of the system and column.
Verify that the system is functioning by using the IQ/OQ documents as reference (See Operation Manual, Appendix)

Shutdown

Upon completion of the analyses, use one of the following two procedures to shut down the Pinnacle PCX system properly. These procedures can prevent potential column damage, reaction coil blockage, high background fluorescence, reagent precipitation, or other problems.

The Pinnacle PCX must be flushed out at the end of a series of injections, and the reactors must be cooled down. If the instrument is simply stopped, with reagent inside the reactor in a hot state, with no movement, then the heated reactor will become blocked. It is very important for a long useful life that the reactors be flushed out until the temperature is cool.

MANUAL SHUTDOWN

You may shutdown the Pinnacle PCX manually by pressing/selecting the **Disable** function in the **Control** menu of the PCX control software.

If you choose this function, allow the HPLC to pump for at least 30 minutes to allow for the reactor to cool and to flush reagent from the reactor.

OR

AUTOMATIC SHUTDOWN

Create a Shutdown Method for Pinnacle PCX according to section 4 of this manual. Set it up as the last method in the Pinnacle PCX sequence. Make sure pump flow rate is set to 0 mL/min and reactor temperature is set close to room temperature. You can leave the column at the operating temperature or set it at room temperature.

Create corresponding slowdown Method for HPLC. Set it up as the last method in the HPLC sequence. Make sure HPLC flushes column and reactor with column storage eluant for at least 30 min.

RECOMMENDED ACCOMPANYING HPLC SLOWDOWN METHOD

Set the HPLC to 100% Storage Eluant (see application section for proper eluant for your column), and set the HPLC pump at the normal analytical flow rate. Choose an eluant that elutes contaminants from the column; for example, methanol for a reversed-phase column and regenerant for an ion-exchange column.

Time (min)	% Storage Eluant	Flow (ml/min)
0	100	Analytical flow rate*
30	100	Analytical flow rate*
30.1	100	0.0 or 0.02mL/min

*Follow instructions that come with the column.

Section 4

PINNACLE PCX OPERATION

- 4.1 Software Overview
- 4.2 Status Window
- 4.4 Menu Options/Functions
- 4.6 Configuring your Pinnacle PCX
- 4.7 Log Files
- 4.7 Creating and Editing Methods
- 4.10 Creating and Editing Sequences
- 4.11 Tutorials
- 4.14 Running Post-column Analysis Using Pinnacle PCX
- 4.17 Stop/Reset Instrument
- 4.17 Pinnacle Shutdown

Software Overview

Pinnacle PCX can be controlled only with PC using Pinnacle PCX software. The system can be connected to PC through USB or Ethernet cable.

Pinnacle PCX software controls column and reactor heaters, electronic valves and pumps. It allows to create, store and run post-column methods and sequences. It monitors reactor and column temperatures, pump pressures and flow rates. It keeps logs that records system parameters and HPLC flags.

COMPUTER REQUIREMENTS

Microsoft Windows XP, Vista, or Windows 7 operating environment

Minimum one free USB port or network connection

Available memory: 10 Mb

HPLC SYNCHRONIZATION

Pinnacle PCX needs to receive injection signal from HPLC to synchronize operation.

For HPLC systems other than Agilent 1100 and Agilent 1200 the HPLC software and system must be capable of sending a relay signal to an external piece of equipment to achieve synchronization.

Agilent Chemstation version 9.0 or higher is needed for Agilent 1100 or Agilent 1200. Pinnacle PCX software will read injection signal from Chemstation directly – no relay connection is needed. If any other software program is used to control Agilent 1100 or Agilent 1200, relays board should be installed on the Agilent pump.

Any machine that drives the relay output shall provide a relay contact pair that is electrically isolated from all other electrical devices. The relay signal must have:

Relay detection voltage	24 ±2V
Relay detection current	Approximately 1 mA

Status Window

The Status window is the main screen of the Pinnacle PCX software (Figure 4-1). The Status window can be moved, or minimized into an icon at the bottom of the PC screen. It has a menu bar on the top, status bar at the bottom and icons for the Pinnacle PCX components.

ICONS

Pump 1: Displays the actual volume in ml of liquid in the syringe. The status bars will increase/decrease with volume. The actual volume is displayed at the bottom of the icon.

Pump 2: Displays the actual volume in ml of liquid in the syringe. The status bars will increase/decrease with volume. The actual volume is displayed at the bottom of the icon.

Column oven temperature: Displays the Set and actual temperature in °C. The actual temperature is displayed at the bottom of the icon. The status bars on the column oven icon will fill in and increase as the column heats. The reverse is true when the column cools. The icon shows the temperature of the column oven to the nearest degree. The recommended maximum temperature for the column heater is 75°C. A thermal safety switch limits the heater at ca. 80°C.

Reactor temperature: Displays the Set and actual temperature in °C. The actual temperature is displayed at the bottom of the icon. The reactor temperature is measured to the nearest degree. The status bars on the reactor oven icon will fill in and increase as the reactor heats. The reverse is true when the reactor cools. The recommended maximum temperature for the heated reactor is 130°C. Above this temperature the reaction coil begins to lose strength. A thermal safety switch limits the heater at ca. 150°C.

Pressure: Displays the actual pressure in bar or psi. Pump 1 pressure corresponds to the actual pressure on Pump 1, and through post-column system beginning at the first mixing tee. Pump 2 pressure corresponds to the actual pressure on Pump 2, and through the post-column system beginning at the second mixing tee.

Flow: Displays the actual flow rate in ml/min of the reagent pumps. When the pump is dispensing at the analytical flow rate, the black square in the icon will move slowly in a clockwise direction. When the pump is refilling, the icon changes to an alternating segments that rotate in a counter-clockwise direction.

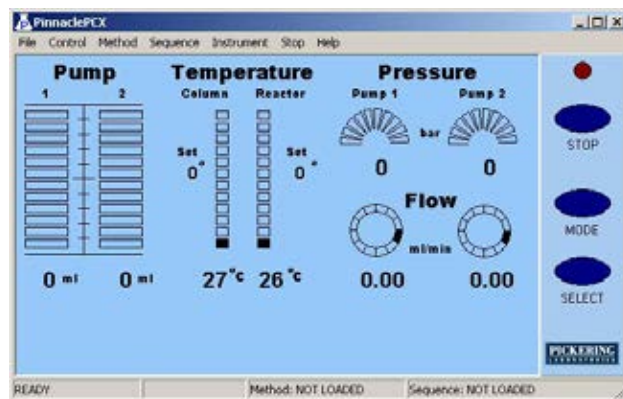

Figure 4.1

MESSAGE AREA

The message area gives details about the status of the instrument. This area describes s, and actions. Some sample messages include:

- Enabled Heaters are On
- Instrument Stopped
- Sequence Stopped
- Finishing Current Run
- Sequence Done
- No Relay Signal

STATUS BAR

The status bar at the bottom of the screen displays the running status (elapsed run time, refilling, ready), loaded method, loaded sequence. The status bar gives very basic information for a quick glance for method loaded and run time.

If in 'Run' mode:

Run Status, i.e. 3 of 7

Elapsed run time in minutes

BUTTONS

The buttons located on the right side of the Main Window emulate the buttons on the right of the LCD on the Pinnacle PCX instrument.

Stop: This will stop the instrument. It does not matter what task the instrument is performing when this is pressed. The Pinnacle PCX will stop whatever it is doing and will not resume until the user has Reset the system. The button activates a red LED when the instrument is stopped. This is an emergency function designed to allow the user to fix any catastrophic problems before they do damage or make a mess.

Mode and Select buttons are used during installation and function only on the instrument.

Menu Options/Functions

FILE

Import/Export exports existing methods and sequences into a file. The file then can be imported to another instance of the Pinnacle PCX software.

Exit closes Pinnacle PCX software.

CONTROL

Enable selecting Enable will cause the reactor and column heaters to begin heating. This will not start the pumps. The Enable button changes to Disable when pressed. Press Disable for the instrument to stop heating. Instrument must be enabled before turning pump(s) ON or starting the sequence.

Refill pump(s) this option will refill pumps to the volume calculated for the currently loaded method. If no method is loaded the full syringe will be refilled. For two-pump instrument there is a choice of refilling pump1, pump2 or both pumps. The pump(s) must be refilled before the sequence is started. The pump(s) will refill automatically between the runs.

Flush pump(s) this option will flush the pumps using solution from the flush bottle. For two-pump instrument there is a choice of flushing pump1, pump2 or both pumps.

Empty pump(s) this option will empty pump(s). For two-pump instrument there is a choice of emptying pump1, pump2 or both pumps.

Pump1 ON turns on Pump1. This option changes to Pump1 OFF when selected.

Pump2 ON turns on Pump2. This option changes to Pump2 OFF when selected.

Both pumps ON turns on both pumps. After this option is selected, Both Pumps OFF option becomes available.

CONTROL menu choices are not available when sequence is running

METHOD

Edit/Delete this option opens Method editing screen where Methods can be created, edited, saved or deleted.

Print this will print Method information to default printer.

SEQUENCE

Edit/Delete this option opens Sequence editing screen where sequences can be created, edited, saved, loaded or deleted.

Print this will print Sequence information to default printer.

Load this loads the selected sequence.

-
- Start sequence** starts the loaded sequence. Instrument must be enabled and pump(s) must be refilled before starting the sequence. After Start Sequence is pressed the following choices become available:
- Stop sequence** after this button is pressed the Pinnacle PCX finishes current run then stops the pump(s) and turns the heaters OFF.
- Pause sequence** this option allows the Pinnacle PCX to finish current run and then stops the pump(s). It leaves the heaters ON. The sequence will continue after Resume Sequence is selected.

INSTRUMENT

Configuration opens the configuration screen.

Maintenance gives the selection of the following operations:

Flush Instrument flushes the pumps and the instrument using solution from the flush bottle. Create and load a method for Pinnacle PCX with suitable reagent flow rates, reactor and column temperature before executing this command. Make sure HPLC is running to avoid backflow into the column.

Change seals prepares the pump(s) for seal change. Follow directions on the screen to complete this procedure

Prepare for storage/shipping flushes the pumps and the instrument in preparation for long term storage or shipping. Follow directions on the screen to complete this procedure.

Pump and valve seal pressure test & system pressure test. Builds up pressure to test the integrity of the seals after a PM.

INSTRUMENT menu choices are not available when sequence is running.

STOP/RESET This option performs the same action as **Stop** button on the front of the instrument. This option is used for an instant stoppage of the instrument in the case of an emergency. The instrument will cease all the activities, regardless of what is happening. The pump(s) and heaters will be turned OFF and all the loaded methods and sequences will be cleared. After **STOP** is selected the option will change to **RESET**. Select **RESET** function when you are ready to start running the instrument again.

HELP

Index this will open searchable Help features for the Pinnacle PCX software.

Send Log to Support

saves logs to file that can be e-mailed to support@pickeringlabs.com . Logs carry information about instrument status from the last 3 days and are necessary to troubleshoot software and instrument problems.

About gives software version number.

Configuring your Pinnacle PCX

Select **Instrument** then **Configuration** to open configuration window (figure 4-2)
The tabs open corresponding windows that allow you to configure the Pinnacle PCX.

Instrument Tab:

Network: Select this option if the Pinnacle PCX will be connected to the computer through a company's network. Enter the network IP address in the spaces provided.

USB Port: Select this option if the Pinnacle PCX will be connected directly to the computer via a USB cable.

Column Tab:

Temperature Range: This window displays the current minimum and maximum column temperature range for the Pinnacle PCX.

Reactor Tab:

Volume, ml: This window displays the current minimum and maximum reactor temperature range for the Pinnacle PCX. The temperature range depends on the volume of the reactor. Enter the volume of the reactor that you are using.

Pump Tab:

Max Volume: 70 ml: This is the volume of the syringe installed on the Reagent pumps(s).

Flow Rate: 0.05 – 1.5 ml/min: This is the flow rate range for the installed Reagent pump(s).

Pressure in: Bar or psi: Select bar if you would like to see the pressure displayed in bars, or psi if you would like to see the pressure displayed in pounds per square inch.

More Tab:

HPLC type: Select the brand of HPLC that you will be using with Pinnacle PCX. This will determine the type of synchronization between Pinnacle PCX and HPLC system.

For HPLC systems other than Agilent 1100 and Agilent 1200 the HPLC software and system must be capable of sending a relay signal to an external piece of equipment to achieve synchronization. Agilent Chemstation version 9.0 or higher is needed for Agilent 1100 or Agilent 1200. Pinnacle PCX software will read injection signal from Chemstation directly – no relay connection is needed. If any other software program is used to control Agilent 1100 or Agilent 1200, relays board should be installed on the Agilent pump.

If your HPLC does not have Relay capabilities, select “No connection to HPLC”.

If you need to connect two Pinnacle PCX to the same PC you need to select multiple instruments during the software installation. For each instrument a separate icon will be created on the desktop that will open a main Pinnacle software window. Configure each instrument before starting operation.

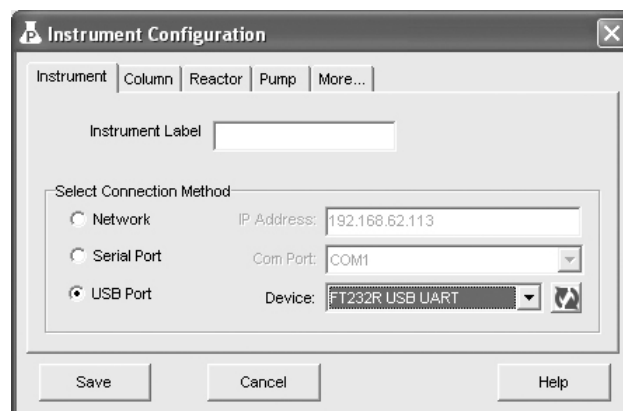

Figure 4.2

Log Files

Pinnacle PCX records detailed information about the instrument parameters in the Log files. Pump(s) flow rates and pressures, reagent volume, column and reactor temperature, s and flags from HPLC are all stored for 3 days before being overwritten. Log files are necessary to troubleshoot Pinnacle PCX system and software and should always be collected after a problem is detected. To collect Log files go to Help, select Send Log to Support and select file from the day the problem happened. Save the file with the date stamp and e-mail it to support@pickeringlabs.com. If you are not sure about the time collect all 3 log files.

Creating and Editing Methods

To run post-column analysis using Pinnacle PCX a post-column method must be created and executed in the Pinnacle PCX software. To create or edit a post-column method select Method then Edit/Delete. This will open Methods editing screen (figure 4-3). To execute methods (even as a single run) they should be part of the sequence.

Methods can be edited when they are currently running. Once edited the method should be saved and the sequence reloaded. New methods and methods not currently running can be added/edited/deleted at any time.

Status Bar This area is located at the top of the Method Edit screen. It displays messages regarding the saving, loading and deleting of methods. For example, when a method called Test 1 is saved, this area will display Method “Test 1” saved.

Method Box This area displays all of the methods currently in memory of the Pinnacle PCX software. Here you can Edit an existing method, Delete a method, or Add a new method. To perform an action on an existing method, click on the method name.

Add Click here to add a new method. The status bar will display Method “name” added.

Delete To delete a method, click once on the method name, then click Delete. The Status bar will display Method “name” deleted.

PUMPS TAB Timetable for both pumps (one table for both). Pump 2 flow rate column is grayed out for 1-pump systems. If timetables are empty the initial conditions are the conditions for the whole run.

Time, min: Enter the time in minutes to the nearest tenth, but not greater than the Runtime. (For example, 0.5 minutes)

P1, ml/min Enter the desired flow rate for Pump1, between 0.05 and 1.5 ml/min. (For example, 1.3 ml/min. This means that Pump 1 will begin pumping 1.3 ml/min at 0.5 minutes)



Figure 4.3

P2, ml/min Enter the desired flow rate for Pump2, between 0.05 and 1.5 ml/min. (For example, 0.08 ml/min. This means that Pump 2 will begin pumping 0.08 ml/min at 0.5 minutes). Enter 0.0 ml/min if you want to stop pumping reagent at a set time during the run.

Add This will add a new line below the currently selected line in the table.

Insert This will insert a new line above the currently selected line in the table.

Delete This will delete the currently selected line in the table.

COLUMN TAB Timetable for the column oven. If timetables are empty the initial conditions are the conditions for the whole run.

Time, min Enter the time in minutes to the nearest tenth, but not greater than the Runtime. (For example, 15.5 minutes)

Temp, °C Enter the desired temperature, in whole numbers, in °C. (For example, 53°C. This means that the column will reach 53°C at 15.5 minutes)

Add This will add a new line below the currently selected line in the table.

Insert This will insert a new line above the currently selected line in the table.

Delete This will delete the currently selected line in the table.

INITIAL SETTINGS In this section, set up the initial conditions for the Pinnacle PCX. If no pump timetable or column timetable is required, Pinnacle will use this information for analysis. The items marked with * indicate required parameters.

***Run Time, min** In this window, enter the total run time for the Pinnacle PCX method. This must be a whole number, greater than 1

***Equilibration Time, min** Enter the time between runs. The Pinnacle PCX will use this information to determine when to begin pumping again prior to the next injection. Minimum time is 5 minutes.

***Column t, °C** Enter the initial column temperature in °C. Enter a whole number between 30°C and 75°C.

Column Type Enter the column type that is used for this application. Any characters are acceptable. There is no limit on number of characters, but 20 are visible in the window at a time.

***Reactor t, °C** Enter the reactor temperature for the analysis. Enter a whole number between 30°C-130°C for reactor volumes ≤2.0ml, or between 30°C-80°C for reactor volumes >2.0 ml. (The reactor volume is set in Configuration).

Reactor Volume, ml Enter the volume of the reactor used in this application.

***Pump 1 Flow rate, ml/min** Enter the initial flow rate for Pump 1. Enter a number between 0.05-1.50 ml/min, or 0

Reagent 1 Enter the name or description of Reagent 1. Any characters are acceptable. There is no limit on number of characters, but 20 are visible in the window at a time.

***Pump 2 Flow rate, ml/min** Enter the initial flow rate for Pump 2. Enter a number between 0.05-1.50 ml/min, or 0. Put 0.0 for a single-pump system.

Reagent 2 Enter the name or description of Reagent 2. Any characters are acceptable. There is no limit on number of characters, but 20 are visible in the window at a time.

ADVANCED SETTINGS

This tab allows you to designate currently open method as a Flush Method (figure 4-4). This method can be set as a last method in the Pinnacle PCX sequence in order to flush the reagent pumps and the Pinnacle PCX reagent lines and reactor. Pinnacle PCX will use solution in the Flush bottle to do this. Always set Flush Method as the last method in the sequence and make sure corresponding HPLC method is created and set as the last method in the HPLC sequence. Flushing is not necessary after every sequence and only recommended before changing applications and long time storage or in the case of extremely aggressive reagents.

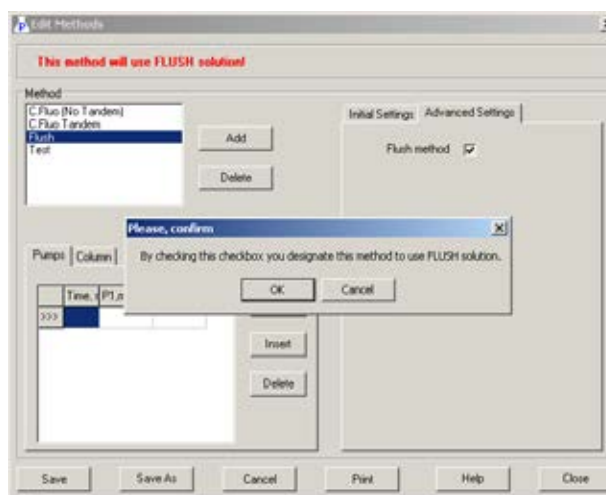

Figure 4.4

ACTION TABS

Save This will save the current method

Save As This will save the current method information using a different name.

Cancel This will close the window and cancel any changes. No changes will be made to the method.

Print This will print the method to the default printer. The information printed will be: print date, operator, method name, save date, initial conditions, pump time table, column time table.

Help This will open the searchable Help features for the Pinnacle PCX software.

Close This will close the window.

IMPORTANT PRACTICAL CONSIDERATIONS

In order to start executing the method Pinnacle PCX needs to receive injection signal from HPLC. To avoid missing the signal it is very important to match Pinnacle PCX method run time and equilibration time to that of your HPLC method.

HPLC pump uses equilibration to return to original conditions before the next analysis. HPLC software programs have different ways of setting up equilibration. Most often used are the following:

- as a PostRun;
- at the end of the pump gradient table;
- as additional time before the injection (set as a PreRun or as negative time in the pump gradient table).

Even if isocratic method is used and no equilibration time is required for HPLC pump Pinnacle PCX still needs at least 5 min of Equilibration time to refill reagent pumps and stabilize the baseline signal before the next injection.

If equilibration for HPLC pump is set up as PostRun or PreRun match Equilibration time in the Pinnacle PCX method to respectively PostRun or PreRun time of your HPLC method. **The run time of your HPLC method (the actual time of the analysis) should be the same as Pinnacle PCX Run time.** Pinnacle PCX delivers reagents only during the Run time set up in the Pinnacle PCX method.

If returning to initial conditions is set as part of the HPLC pump gradient table (at the end or as a negative time step in the beginning) consider how long the actual analysis and equilibration steps are. Match analysis time to Run time of the Pinnacle PCX and match time of the equilibration step to Equilibration time of the Pinnacle PCX.

Creating and Editing Sequences

To create or edit a post-column sequence select Sequence then Edit/Delete. This will open Sequence editing screen (figure 4-5).

Status Bar This area is located at the top of the Sequence Edit screen. It displays messages regarding the saving, creative and deleting of sequences. For example, when a sequence called Test 1 is saved, this area will display Sequence “Test 1” saved.

Select/Edit Sequence Box This area displays all of the sequences currently in memory of the Pinnacle PCX software. Here you can Edit an existing sequence, Delete a sequence, or Add a new sequence. To perform an action on an existing sequence, click on the sequence name.

Create Click here to add a new sequence

Delete To delete a sequence, click once on the sequence name, then click Delete.

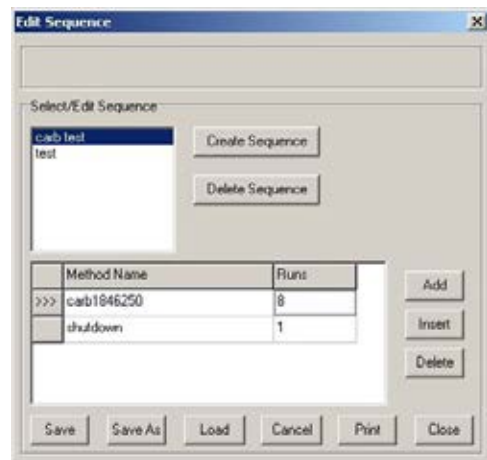

Figure 4.5

SEQUENCE TABLE WINDOW

Method name	Number of runs
Select the method name from the drop down menu	1-...

Add This will add a new line below the currently selected line in the sequence.

Insert This will insert a new line above the currently selected line in the sequence.

Delete This will delete the currently selected line in the sequence.

The end of the sequence should be with a shutdown method or a flush method.

ACTION TABS

Save This will save the current sequence.

Save As This will save the current sequence information using a different name.

Load This will load the current sequence into the Pinnacle PCX software.

Cancel This will close the window and cancel any changes.

Print This will print the sequence to the default printer. The information printed will be: print date, operator, sequence name, sequence table (with method names), save date.

Help This will open the searchable Help features for the Pinnacle PCX software.

Close This will close the editing window.

EDITING THE RUNNING SEQUENCE:

- select the Sequence name from the Sequence Box.
- change number of runs of the currently running Method or add a new line to the Sequence anywhere below the Method in progress.
- select **Save** and then **Load** from the Actions tabs.
- check number of runs on the bottom of the main software window to confirm that changes has taken affect.

Tutorials

CREATE A METHOD

The following is a tutorial on how to create a method and start a run on the Pinnacle PCX. It is not intended to be used for a real run because the flow rates and temperatures are not representative. If you like, you may use this tutorial as a guide to create your own methods.

This example is a fictitious method and is not intended to analyze samples.

Double-click on the Pinnacle PCX icon on your desktop. This will open the main Status Window of the Pinnacle PCX software.

Go to **Method**, then select **Edit/Delete**. This will open the Method Edit Screen. Here you will set the initial conditions, flow rates, temperatures for your method.

Click Add Method.

Type a Name for your method. For this example, type “Tutorial”, and click OK.

The Pinnacle PCX software has now added the method “Tutorial” to the list of available methods. Highlight this method if it is not already done so.

Under **Initial Settings Tab**, type:

Run Time, min: 60

Equilibration Time, min: 5

Column t, °C: 38

Column Type: 1154150 Na cation exchange

Reactor t, °C: 36

Reactor Volume, ml: 0.5

Pump 1 Flow rate, ml/min: 0.3

Reagent 1: Hypochlorite

Pump 2 Flow rate, ml/min: 0.3

Reagent 2: OPA

Click on the **Pumps Tab**, then click once in the box under Time. The cursor should now be flashing here. Type in your desired Times and flow rates below. Use the **Add** button to add lines to the table. Use the data from the table below as a guide. Time is the elapsed time in minutes. P1 and P2 are the flow rates of each pump in ml/min.

Time, min	P1, ml/min	P2, ml/min
1.0	0.3	0.5
1.6	0.8	0.0
3.8	1.0	0.05
12.5	0.0	0.05
30	0.1	0.0

Next, click on the **Column Tab**, then click once in the box under Time. The cursor should now be flashing here. Type in your desired Times and temperatures below. Use the **Add** button to add lines to the table. Use the data from the table below as a guide. Time is the elapsed time in minutes. Temperature is in °C and is the desired temperature of the column at the time specified.

Time, min	Temp, °C
5.0	45
9.5	48
25	56
50	75

Now Click **Save**. This has saved the conditions you have created in the method “Tutorial”.

Click **Close** to close the Edit Method Window.

Next, we will go through the Create Sequence Tutorial.

CREATE A SEQUENCE

As with the above method, this example sequence is not designed to be used for analysis. It will guide you through the steps and you may use your own method for the Sequence Table.

From the main Status Window, go to **Sequence**, then select **Edit/Delete**.

This will open the Sequence Edit Screen. Here you will set the method names, and the number of injections for each method.

Click Create Sequence.

Type a Name for your Sequence. For this example, type “Tutorial 1” and click OK.

The Pinnacle PCX software has now added the Sequence “Tutorial 1” to the list of available sequences. Highlight this sequence if it is not already done so.

Under Method Name, there is a drop down menu. Choose the Method “Tutorial”.

Next, under the Runs, type in the number of injections you plan to make using this method. In this example, it will be 3.

Your table should now look like:

Method Name	Runs
Tutorial	3

The number of Runs should match the number of runs you plan to make on the HPLC using that method. In this example, your system will perform 3 injections using the Pinnacle PCX method “Tutorial”. The sequence table on your HPLC system should also have 3 injections programmed.

Now Click **Save**. This has saved the conditions you have created in the sequence “Tutorial 1”.

Click **Close** to close the Edit Sequence Window.

Running post-column analysis using Pinnacle PCX

To start running post-column analysis using Pinnacle PCX follow the steps below:

Create analytical method(s) for your HPLC system using gradient conditions and detector settings from Pickering Laboratories application notes or other sources. **For any other HPLC software except Agilent Chemstation, set the relay start signal close to time 0.** Depending on the software the relay stop signal can be either a few minutes after injection or at the end of the run. Contact your HPLC support representative if you have any questions about setting up relay signal in the HPLC method.

Create post-column method(s) for your application using post-column conditions from Pickering Laboratories application notes or other sources.

Set up HPLC sequence. Contact your HPLC support representative if you have any questions about creating and running HPLC method or sequence.

Start HPLC pump. Increase the flow rate gradually to avoid overpressuring the analytical column.

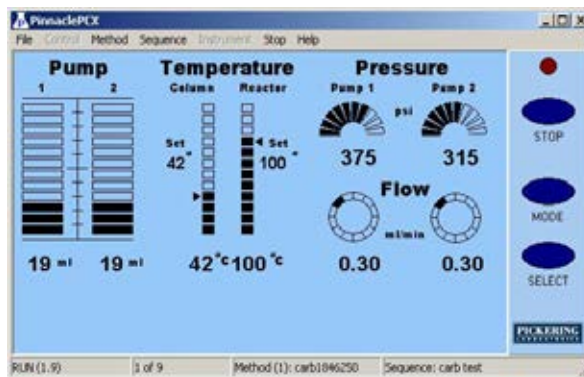

Figure 4.6

Create sequence for Pinnacle PCX using your post-column method(s). Set up the same number of runs as in the HPLC sequence.

Select **Save** to save Pinnacle PCX sequence.

Select **Load** to load Pinnacle PCX sequence. Sequence name and the first method name will appear in the status bar at the bottom of the Pinnacle PCX software.

Select **Control – Enable** to turn column and reactor heaters ON. Set and actual temperatures will be displayed on the heaters icons. Wait until the actual temperature reaches the set point.

Select **Control – Flush both pumps** if this is the first run after the installation or if the instrument was not in use for a long time.

Select **Control – Refill Pump(s)** to fill pumps with reagent. Empty pumps first if there is any old reagent left or if instrument was turned OFF earlier. The pump icon should show partially filled syringe and actual volume of reagent inside (Figure 4-6).

NOTE: If the instrument was turned OFF with partially filled pumps the icons will show alternated black and white segments and no volume data will be displayed. This means that the instrument does not know the position of the piston inside the syringe. Select **Control – Empty Pump(s)**. This will allow Pinnacle PCX to find empty position.

Once reactor and column temperatures are stable and analytical column is equilibrated select **Control – Both pumps ON** (or **Pump ON** for single-pump instrument) to start pumping reagents. Wait until the pressures are stable.

NOTE: Pinnacle PCX software will calculate needed reagent volume based on your run time and reagent flow rate. Some extra volume will be added to that to ensure pumps will not run out of reagent during operation. Do not run pumps for more than 5 min before starting the sequence to avoid running out during the analysis.

Select **Sequence – Start Sequence**. Run time (0.0) will be displayed in the Status Bar at the bottom of the Pinnacle PCX software. Pinnacle now waits for injection signal from HPLC in order to start running the method.

Start HPLC sequence. Once an injection is made Pinnacle PCX software will receive an injection signal via relays or directly from Agilent Chemstation. After that Pinnacle will start the post-column method. Check the timer at the bottom of the Pinnacle PCX software to make sure it matches the elapsed time of the HPLC run.

NOTE: after starting a new sequence always make sure that first injection signal was received normally by checking that Pinnacle PCX timer matches elapsed time of the HPLC run. Pinnacle PCX will stop the sequence if no injection signal is received from HPLC in 15 min from selecting **Start Sequence**.

After the post-column method Run time is done Pinnacle PCX turns the pump(s) OFF , checks temperature and flow rate settings for the next run and automatically refills the reagent. Pinnacle PCX will turn the pump(s) ON 5 min before the end of the Equilibration time.

Once next injection signal is received Pinnacle PCX starts the second method in the sequence. The number of the current run and total number of runs in the Sequence are shown on the bottom of the Pinnacle PCX software.

After Sequence is complete Pinnacle PCX turns OFF the pump(s). Message “Sequence done. (Runs n of N)” is displayed in the software window.

Important Practical Considerations

Always match number of runs in HPLC and Pinnacle PCX sequences. If more samples are added to HPLC sequence or samples are removed edit Pinnacle PCX sequence accordingly. Total number of samples displayed by HPLC software often does not include calibrators and controls. Make sure you count total number of runs in HPLC sequence not just number of samples before creating Pinnacle PCX Sequence.

To edit the running Sequence:

- select **Sequence – Edit/Delete**
- select the Sequence name from the Sequence Box.
- change number of runs of the currently running Method or add a new line to the Sequence anywhere below the Method in progress.
- select **Save** and then **Load** from the Actions tabs.
- check number of runs on the bottom of the main software window to confirm that changes has taken affect.

We recommend restarting Pinnacle PCX software after Sequence is completed.

STOP/RESET Pinnacle PCX

In a case of an emergency there are two ways of stopping Pinnacle PCX:

On the front of the instrument press STOP button. To reset turn the instrument OFF and ON again.

In the Pinnacle PCX software select **STOP**. Once selected this option changes to **RESET**. Select **RESET** once the emergency is cleared.

These options are used for an instant complete stoppage of the instrument. Pinnacle PCX will cease all the activities, regardless of what is happening. The pump(s) and heaters will be turned OFF and all the loaded methods and sequences will be cleared. When ready (after the problem is fixed and you have rinsed the analytical column) load a sequence again and follow steps to start post-column analysis.

Pinnacle Shutdown

Pinnacle can be shut down at the sequence by either using a Shutdown method or a Flush method. The latter is recommended if the instrument is to be stored for a long time or if reagents will be changed.

Upon completion of the analyses, use one of the following two procedures to shut down the Pinnacle PCX system properly. These procedures can prevent potential column damage, reaction coil blockage, high background fluorescence, reagent precipitation, or other problems. The Pinnacle PCX must be flushed out at the end of a series of injections, and the reactors must be cooled down. If the instrument is simply stopped, with reagent inside the reactor in a hot state, with no movement, then the heated reactor will become blocked. It is very important for a long useful life that the reactors be flushed out until the temperature is cool.

MANUAL SHUTDOWN

You may shutdown the Pinnacle PCX manually by pressing/selecting the **Disable** function in the **Control** menu of the PCX control software.

If you choose this function, allow the HPLC to pump for at least 30 minutes to allow for the reactor to cool and to flush reagent from the reactor.

AUTOMATIC SHUTDOWN

Create a Shutdown Method for Pinnacle PCX using the following settings as an example:

Run time:	30 min
Equilibration time:	5 min
Reactor temperature:	35 C
Column temperature:	35 C
Pump(s) flow rate:	0 mL/min

Set it up as the last method in the Pinnacle PCX sequence. Make sure pump flow rate is set to 0 mL/min and reactor temperature is set close to room temperature. You can leave your column at your operating temperature or set it at room temperature.

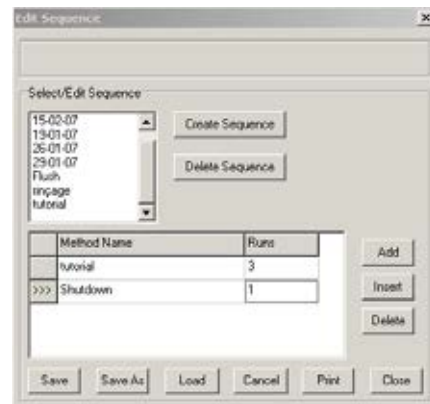

Figure 4.7

Create corresponding slowdown Method for HPLC. Set it up as the last method in the HPLC sequence. Make sure HPLC flushes column and reactor with column storage eluant for at least 30 min.

RECOMMENDED ACCOMPANYING HPLC SLOWDOWN METHOD

Set the HPLC to 100% Storage Eluant (see application section for proper eluant for your column), and set the HPLC pump at the normal analytical flow rate. Choose an eluant that elutes contaminants from the column; for example, methanol for a reversed-phase column and regenerant for an ion-exchange column.

Time (min)	% Storage Eluant	Flow (mL/min)
0	100	Analytical flow rate*
30	100	Analytical flow rate*
30.1	100	0.0

*Follow instructions that come with the column.

Section 5

MAINTENANCE

- 5.1 Maintenance Suggestions
- 5.2 Operating Suggestions
- 5.3 Proper Shutdown Procedures
- 5.6 Basic Maintenance Procedures
- 5.7 Reagent Filter Replacement
- 5.8 Ambient Reactor Replacement
- 5.8 Replacement of Heated Reactor Cartridge
- 5.9 Valve Maintenance
- 5.12 Pump Seal Replacement
- 5.16 Fuse Replacement
- 5.17 Tubing Kit Guides

Your Pickering Pinnacle PCX will require some routine maintenance to stay in top condition. Ordinarily, little maintenance is needed beyond good operating procedures. In this section you will find some suggestions for maintaining your Pinnacle PCX, as well as Proper Shutdown procedures for typical, Long-term, and Storage of the Pinnacle PCX.

Maintenance Suggestions

Make copies of the blank forms in the Appendix and complete the parameter log on the photocopy.

Record the pressures for the system equilibrated under initial conditions. Keep a daily log of Column, Pump 1 and Pump 2 (if applicable) pressures for diagnostic use. Include all the settings for the pump, injector, detector, and integrator.

Record any repairs, or problems in the Instrument Log.

Keep copies of the QC chromatograms and logs, and of the initial chromatograms generated at installation.

Create a maintenance schedule for your laboratory to ensure that the instrument is kept in good working order.

Always use PEEK nuts and ferrules in the Pinnacle PCX fluidics lines. **Use of stainless steel nuts and ferrules in the PEEK ports will void the warranty.** Stainless steel nuts and ferrules will cut the threads at the bottom of the ports, causing them to leak. If this happens, the entire item may need replacing.

Operating Suggestions

Below are several helpful suggestions and bits of information which will help keep your Pinnacle PCX, columns, and reagents in top condition. The following information is broken down into sections for convenience.

There are two items that should be part of any good laboratory practices, regardless of what equipment is being used:

- 1) Always wear safety glasses or goggles, laboratory coat, gloves, and other appropriate safety-clothing.
- 2) Read and understand the instructions in the MSDS's shipped with the chemicals. If the MSDS's are missing, please contact Pickering Laboratories and we can fax you a copy, or you can download them from our website at www.pickeringlabs.com.

PINNACLE PCX

Check for leaks daily at the column fittings; the eluants can be corrosive.

Frequently observe and record the pressures and check for leaks. You may find a problem before it becomes serious.

Always use the correct fuse. Use of the incorrect fuse can seriously damage the PC board and even the valves, reactor and pump. **Use of an incorrect fuse will void the warranty.**

Disconnect the power cord before removing the case of the Pinnacle PCX.

Always follow the proper shutdown procedures. See Below.

Use the proper start-up and shutdown procedures consistently (see Section 4).

Periodically Flush the instrument to ensure long life.

Do not operate the heated reactor above the boiling point of the eluant unless the back-pressure regulator is connected to the waste line of the detector. Boiling inside the reactor can cause precipitates to block the reactor.

Operating above the boiling point without a back pressure regulator will void your warranty.

Thoroughly clean any leaks from fittings with water and dry with paper towels, especially if the solution is a buffer or hydroxide. Standing salt and hydroxide solution are corrosive.

Soak up spills with rags, paper towels, or sponge. Clean spill-area with a wet towel and thoroughly dry. Do not spray water directly into the instrument.

Rinse out the drip tray periodically.

MAINTENANCE SCHEDULE

Check for leaks around all fittings and record column and reagent pressures daily.

Change the reagent filter every 3 months.

Change valve and pump seals every 12 months.

Change the heated reactor and all tubing every two years.

PICKERING COLUMNS

Do not operate with a column pressure above 2800 psi (193 bars) for an extended period of time. Isolate the source of the high pressure and replace those items.

Never disconnect any fittings between the pre-column check valve and the column until the post-column system has been shut down and depressurized (loosen the detector inlet fitting first). If the column pressure drops below the post-column pressure, it is possible for reagent to back-flow onto the column.

When removing the column, remove the outlet fitting first.

Never pump organic solvent through an ion-exchange column. This will swell the resin and over-pressure the column. Never pump high pH buffers or hydroxide through a silica column. This can dissolve the silica and cause extensive damage to the post-column system by permanently blocking tubing.

When switching a system between ion-exchange and reversed-phase applications, be sure to flush the HPLC and injector with water before connecting the column. Eluants for one analysis may damage the column for the other.

ELUANTS AND REAGENTS

Thiofluor is extremely hygroscopic. Always keep it in a tightly closed container.

Sodium borate (any grades) contains excessive amounts of heavy metal contaminants and insoluble matter. These impurities will eventually precipitate in the reactor and flowcell. **The one year warranty does not cover damage caused by these contaminants.**

If you must prepare your own borate buffer for the OPA reagent, **do not use sodium tetraborate** as suggested by the EPA methods. Instead, use molar equivalents of boric acid and sodium hydroxide, because they are available in higher purity (ACS-grade or better) and have very little insoluble matter.

Use Pickering Laboratories reagents and eluants. The quality of the chemicals is guaranteed and the cost is low relative to the worth of your analytical results. **The one year warranty does not cover damage caused by poor-quality reagents and eluants not purchased from Pickering Laboratories.**

Do not touch the interior of the mobile phase reservoirs and the dip tubes with your fingers. Amino acids in fingerprints will cause contamination. Gloves are suggested.

Do not leave caps and lines dangling without a reservoir. To fill reservoir, transfer caps and lines into a spare bottle or an Erlenmeyer flask filled with deionized water.

Proper Shutdown Procedures

Upon completion of the analyses, use one of the following two procedures to shut down the Pinnacle PCX system properly. These procedures can prevent potential column damage, reaction coil blockage, high background fluorescence, reagent precipitation, or other problems.

The Pinnacle PCX must be flushed out at the end of a series of injections, and the reactors must be cooled down. If the instrument is simply stopped, with reagent inside the reactor in a hot state, with no movement, then the heated reactor will become blocked. It is very important for a long useful life that the reactors be flushed out until the temperature is cool.

MANUAL SHUTDOWN

You may shutdown the Pinnacle PCX manually by pressing/selecting the **Disable** function in the **Control** menu of the PCX control software.

If you choose this function, allow the HPLC to pump for at least 30 minutes to allow for the reactor to cool and to flush reagent from the reactor.

OR**AUTOMATIC SHUTDOWN**

Create a Shutdown Method for Pinnacle PCX according to section 4 of this manual. Set it up as the last method in the Pinnacle PCX sequence. Make sure pump flow rate is set to 0 mL/min and reactor temperature is set close to room temperature. You can leave the column at the operating temperature or set it at room temperature.

Create corresponding slowdown Method for HPLC. Set it up as the last method in the HPLC sequence. Make sure HPLC flushes column and reactor with column storage eluant for at least 30 min.

RECOMMENDED ACCOMPANYING HPLC SLOWDOWN METHOD

Set the HPLC to 100% Storage Eluant (see application section for proper eluant for your column), and set the HPLC pump at the normal analytical flow rate. Choose an eluant that elutes contaminants from the column; for example, methanol for a reversed-phase column and regenerant for an ion-exchange column.

Time (min)	% Storage Eluant	Flow (mL/min)
0	100	Analytical flow rate*
30	100	Analytical flow rate*
30.1	100	0.0

*Follow instructions that come with the column.

LONG-TERM SHUTDOWN

The above methods are used if the Pinnacle PCX will be used again within 3 days of the last run. If you plan to not use the Pinnacle PCX for more than 3 days, we recommend that you use the Long-term Shutdown.

In this procedure, the reactor is flushed free from reagent, thus ensuring that it will be free from blockage upon your return.

There are two ways to perform this shutdown; automatic, or manual.

MANUAL LONG-TERM SHUTDOWN

Make sure your HPLC pump is running storage eluant through the analytical column (see Application section for proper eluant) and then remove the column for storage. Replace the column with a union and the eluants with Water and Methanol. Set the HPLC pump to 80% Water and 20% Methanol at 1.0 ml/min. This will prevent backflow into the column during Flush procedure.

Create a Flush method as described in section 4.9 under the Advanced Settings tab of this manual. Set up a Sequence with one run of a Flush method and load it into Pinnacle PCX software.

Select **Enable** function in the **Control** menu.

Select **Instrument – Maintenance- Flush Instrument**. Follow directions on the screen to complete this procedure.

After Flush Instrument is completed select Disable function in the Control menu of the Pinnacle PCX software to turn OFF heaters and pumps.

Allow the HPLC to pump at least 30 minutes to allow for the reactor to cool.

AUTOMATIC LONG-TERM SHUTDOWN

Create a Flush method as described in section 4.9 under the Advanced Settings tab of this manual. Set it up as the last method of your Pinnacle PCX sequence.

Create a corresponding method for your HPLC to flush analytical column with the storage eluant (see Application section for proper eluant) and set it up as a last method of your HPLC sequence.

After sequence is completed select Disable function in the Control menu of the Pinnacle PCX software to turn OFF heaters and pumps.

Allow the HPLC to pump at least 30 minutes to allow for the reactor to cool.

STORAGE

If the Instrument will not be used for a period longer than 2 weeks, it must be put into Storage state. This becomes necessary because as reagents age, the chances of precipitation in the heated reactor increases.

Perform Manual or Automatic Long-Term Shutdown as described above.

Remove the reagents and replace them with a solution of 80/20 Water/Methanol.

Select Refill **Pump(s)** from **Control** menu of the Pinnacle PCX software. This will flush the reagent lines from the bottles from the remaining reagent.

Select in the Pinnacle PCX software **Instrument – Maintenance – Prepare for Storage/Shipping**. Follow directions on the screen to complete the procedure.

Pump the storage eluant through the analytical column (see Application section for proper eluant), and remove the column and guard.

Cap both column and guard tightly.

Replace any buffers with water and flush the HPLC lines for 5 minutes.

Replace the water with 80/20 Water/Methanol and flush the lines.

Place a restrictor or union in the column oven in place of the column.

Pump 80/20 Water/Methanol through the system.

Basic Maintenance Procedures

The following section will describe the procedure for cleaning/replacing/rebuilding key elements of the Pinnacle PCX instrument.

For the following procedures, refer to Figure 5-1 below, which calls out the various parts of the Pinnacle PCX.

Starting at the valves, the parts of the Fluidics Panel are numbered counter-clockwise.

1. Valve 2 (on dual systems only)
2. Pressure Transducer 2 (on dual systems only)
3. Gas is controlled by the toggle valve. Lever ON pressurizes the manifold.
4. Pump 2 (on dual systems only)
5. Column Outlet
6. Mixing Manifold 2 (with integrated reagent filter) (on dual systems only)
7. Heated Reactor
8. Mixing Manifold 1 (with integrated reagent filter and over-pressure relief valve)

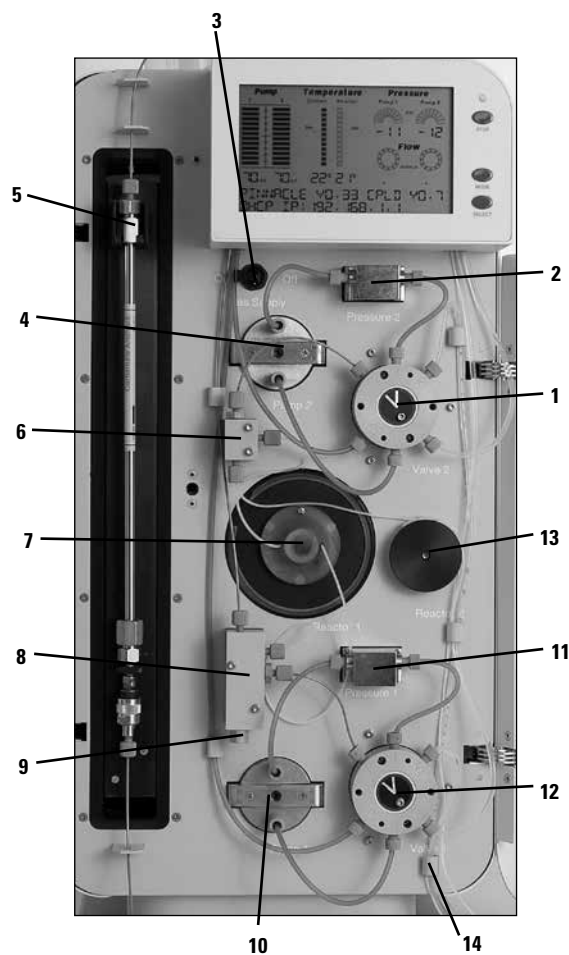

Figure 5-1

9. Over pressure Relief valve
10. Pump 1
11. Pressure Transducer 1
12. Valve 1
13. Ambient reactor (on dual systems only)
14. Reactor outlet and union to connect to detector

Reagent Filter(s) Replacement

Refer to Figures 5-1 and Figure 5-2 for the location of the Reagent filter(s).

There are two filters in the Duplex system, and one filter on the Simplex system. They are located in the reagent manifolds; Items 6 and 8.

1. Be sure that the Pinnacle PCX is shut down and depressurized before changing a filter.
2. Remove the 1/16" fitting from the inlet of the reagent filter.
3. Use a 7/16" wrench to remove the filter.
4. Replace the filter element. The correct filter element is 3102-9040, a 10 μm frit. Tighten with fingers first, then give it a 1/4 turn with a 7/16" wrench

Reconnect the tubings to the filter. Use care not to strip the threads, and do not overtighten. Start the LC pump and inspect for leaks.

Note: Always use a PEEK nut and ferrule to connect to the reagent filters. They are made of soft PEEK material, and stainless steel nuts and ferrules will cut them, causing them to leak.



Figure 5-2

Ambient Reactor Replacement

The Ambient Reactor is Item 13 (on dual systems only).

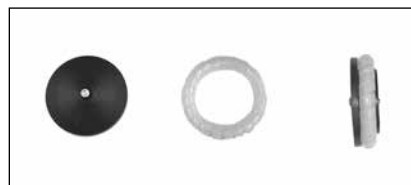

Figure 5-3

1. Shutdown the post-column system and let the reactor cool for at least 30 min.
2. Disconnect the two fingertight fittings at either end of the ambient reactor. These will be located on the manifold (Item 6) and the inlet of the detector.
3. Loosen the screw that holds the black spindle to the fluidics panel with a 3/32" Allen wrench.
4. Remove the spindle and remove the used reactor.
5. Slide the new reactor onto the spindle and fasten to the fluidics panel.
6. Re-connect the fingertight fittings to the manifold and the union (Items 6 and 14). Do not overtighten the fittings.
7. Start the LC pump and inspect for leaks.

Replacement of Heated Reactor Cartridge

The Heated Reactor is Item 7. Please refer to Figure 5-4 for removal of the Reactor Cartridge.

1. Shutdown the post-column system and let the reactor cool until it is a safe temperature for handling (below 30°C).
2. Disconnect the fingertight fittings connected to the heated reactor. These will be located on the manifolds (Items 6 and 8) for duplex systems or on the manifold and union in simplex systems (Items 8 and 14).
3. Loosen the retaining screw at the top of the reactor cartridge using a flathead screwdriver (see Figure 5-4).
4. Gently slide the Reactor Cartridge out of the reactor housing.
5. Replace the heated reactor cartridge with the proper volume (see Appendix).
6. Reconnect the two fingertight fittings. Do not overtighten. The inlet tubing of the heated reactor is marked with a piece of black shrink tube and connects to mixing manifold I (Item 8).
Start the LC pump and inspect for leaks.

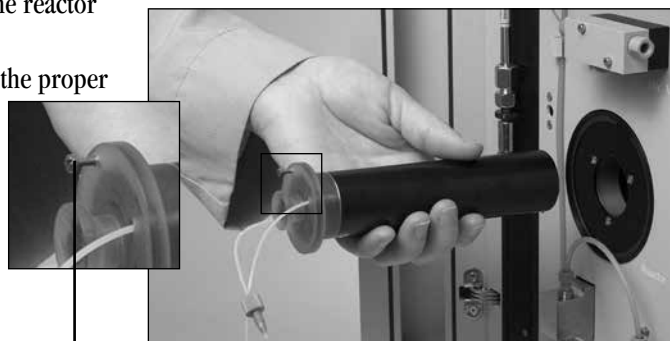

Retaining Screw

Figure 5-4

Valve Maintenance

Flushing the Valves is recommended before valves replacement or resealing to remove reagents from lines and pumps. To flush the valve follow the steps below:

Remove the reagents and replace them with a solution of 80/20 Water/Methanol.

Select Refill Pump(s) from Control menu of the Pinnacle PCX software. This will flush the reagent lines from the bottles from the remaining reagent. Select empty pump(s) to dispense liquid from pump.

Select Flush Pump(s) from Control menu of the Pinnacle PCX software.

Now Valves are ready for maintenance.

VALVE FACE REMOVAL PROCEDURE

Replace the post-column reagents with 80/20 water/methanol.

Flush the pump connected to the valve that requires maintenance (in the software, go to **Control**, then **Flush Pump**).

When the flush is complete, pull the Flush tubing out of the liquid to prevent siphoning of the liquid back into the flush line.

Power down the Pinnacle PCX and turn the power back on again. This will move the valve to the blocked position. This is important for alignment of the new or repaired valve face.

Place some paper towels under the Pinnacle PCX to absorb any excess liquid that is in the Flush line.

Disconnect the Waste line (position 6) from the Valve face. Hold the end of the tubing upright for a moment to allow any liquid to drain into the waste container.

Disconnect the remaining fittings from the valve face.

Using an Alan wrench and a flat-head screwdriver, loosen the cap screw that holds the valve indicator plate in the center of the valve, and the 2 flat-head screws located between ports 1-2 and 4-5.

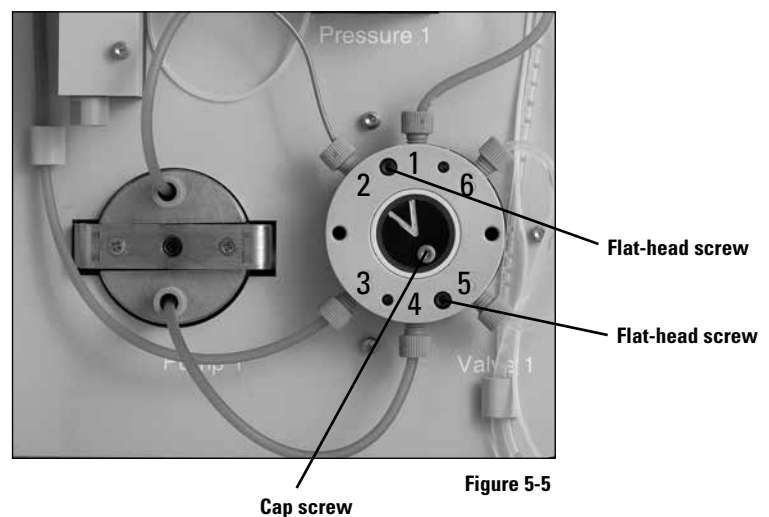

Pull the entire face horizontally forward. There will be some resistance.

If there has been any crystal build-up behind the valve, insert the jack screws contained in the Valve Maintenance kit and tighten them until the face of the valve comes forward and you are able to remove it (figure 5-7).

Warning: When removing the valve face with the jack screws, it is important to remember to remove the valve using equal turns on each side. It is important that it come off of the instrument as straight as possible to prevent deforming the soft PEEK material.

Remove the jackscrews after the valve is removed.

Inspect the face of the motor mount. Ensure that there is no excess crystal build up. Carefully clean any crystals with a paper towel and some DI Water.

Using the Pinnacle Valve Seal tool, turn insert clockwise and push to remove spool (figure 5-8).

O-RING REMOVAL

DO NOT use any sharp tools as this will scratch the soft plastic of the insert.

For the 5 smaller O-rings (Size 4) – use a length of 1/16 OD Peek tubing to remove.

For the 2 large O-rings (Size 18) – pinch o-rings with fingers and roll to remove.

Once O-rings are removed, sonicate PEEK ring and PTFE insert to remove any crystals from valve. O-rings will be replaced.

O-RING REPLACEMENT

Clean the new O-rings first by sonicating them in a soapy water bath for 20 minutes and then rinse thoroughly with DI Water. Wear gloves and use care not to get dust or dirt on them after cleaning.

Push the 5 new Size 4 O-rings into the ports of the PEEK ring. Port 6 (Waste port) does not have an O-ring.

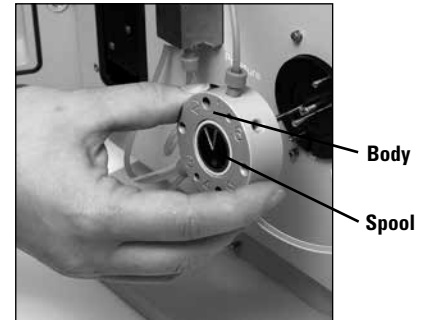

Figure 5-6

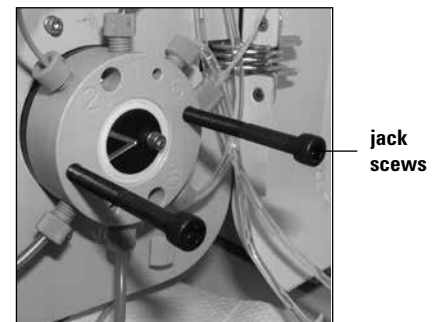

Figure 5-7



Figure 5-8

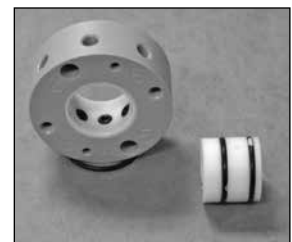

Figure 5-9

Carefully slide the 2 new Size 18 O-rings onto the white center spool.

Note: Never reuse the O-rings. They take a shape after they are installed and will not conform to a new shape.

Note: Never use substitute O-rings.

Only use O-rings provided and approved by Pickering Laboratories.

INSERTING THE SPOOL INTO THE PEEK RING

Using the special Pinnacle Valve Seal tool (the same tool used to remove the spool), carefully put the PTFE center back into place in the PEEK ring. Rotate the insert clockwise to prevent slicing of the O-rings. Look into the valve, and push insert toward you to ensure that no O-rings pop out.

Line up the holes in the spool so that when it is placed on the Pinnacle, the V is between ports 2-3. This is the equivalent to the blocked position of the insert.

REPLACING THE NEW/REBUILT VALVE ON THE PINNACLE

Ensure that at the front face of the new valve, the body and spool are completely flush. These two pieces must be level.

Slide the new valve onto the motor mount, so that the Number 1 is at the top.

Ensure that the dowels match the openings in the back of the valve.

Ensure that the V is between ports 2-3 (that is, ensure that the spool is in the home blocked position) refer to figure 5-10.

Push the valve face firmly against the Pinnacle PCX. Ensure that the Valve Spool is firmly pushed against the motor mount.

Replace the cap screws and tighten until you feel slight resistance. Then make 1/8 turn past snug.

Perform a pump flush to exercise the new valve and to properly position the spool within the body (remember to put flush lines back into the solution).



Figure 5-10

Pump Seal Replacement

The Pinnacle PCX uses Pickering's own pulse-free syringe pump with piston wash. The pump is specially designed for extended seal life, however the piston seals will require periodic replacement. The length of service to be expected from the seal depends on a wide variety of factors, including whether proper shutdown procedures were followed, how often the system was turned on and off, and whether the piston-wash system was wetted.

It is critically important that the seal be replaced immediately upon failure, or better yet, before failure, because the reagent can leak into the mechanical housing of the pump and cause corrosion. When a leak occurs, you may notice fluid on the side of the pump.

The pumps are Items 4 and 10.

SOFTWARE SET UP

To replace the seals, open the PCX control software and select **Maintenance** under the **Instrument** menu. From the **Maintenance** sub-menu, select **Change Seal**, and follow the onscreen instructions.

Wait until the end of a run before performing this procedure to conserve reagent.

The Pinnacle will perform the Flush pump sequence, and will flush reagent out of the syringe.

Pull the Piston Wash and Flush lines out of the liquid, so they are just inside the caps. Leave enough space for the pump to dispense any remaining liquid into the bottles.

When you are ready, click OK on the software.

The pump will retract the piston to dispense any piston wash back into the bottle.

Next, the pump will move the piston all the way forward to empty any remaining liquid into the Flush bottle.

The Valve will move to the blocked position to prevent any flow from the bottles.

Disconnect the Reagent lines from the pump head and plug the openings to prevent any spillage.

Open the panel on the right side of the Pinnacle PCX by removing the captive screw located at the back of the Pinnacle PCX, then push the cover back, and lift it up.

TO REMOVE THE PUMP FROM PINNACLE PCX

Turn off Pinnacle PCX.

Disconnect the electronic pin connector from the inside wall of the Pinnacle PCX.

Remove the two Alan bolts from the bottom of the pump first. See Figure 5-11.



Figure 5-11

Note: It is very important to remove the bottom bolts first. There are specially designed hooks in the chassis that will support the pump.

Loosen and remove the third top screw. Use caution as this will cause the pump to lean toward you. Brace the pump toward the wall of the Pinnacle PCX to prevent damage.

Carefully remove the pump from the chassis. If it is Pump 1, tilt the back end up and remove the pump in a vertical position. If it is Pump 2, tilt the back end down, and remove the pump in a vertical position.

Place the pump on clean paper towels on the bench.

Wear gloves for this procedure.

REMOVE SYRINGE FROM BODY OF THE PUMP

Once the pump is on the bench, carefully remove the syringe from the body of the pump:

Using a 3/32" Allen wrench, loosen the set screw (DO NOT remove set screw) at the front of the syringe. It is important to perform this step first, as it will remove the tension from the bracket pins and cap screws (figure 5-12).

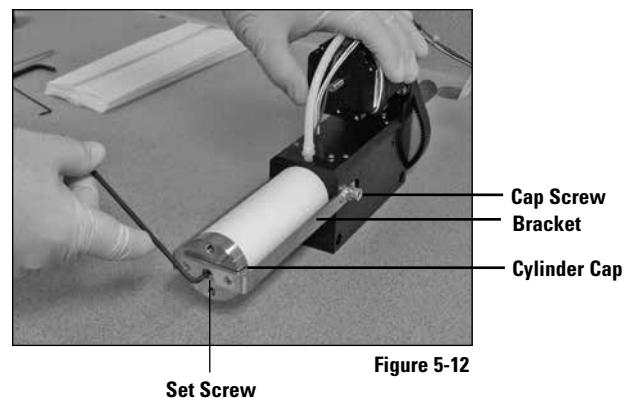

Figure 5-12

Once the set screw is loose, using the 3/16" Allen wrench, loosen the two cap screws that secure the bracket to the pump base.

Remove the bracket and cylinder cap by gently pulling the bracket ends out and away from the pins.

Carefully remove the ceramic syringe body by turning it in a clockwise direction as you pull toward you (figure 5-13).

Warning: Never turn ceramic syringe body counter clockwise. This will cause the Piston Head to unscrew and fall off inside of the cylinder, making it very difficult to remove.

There will be some liquid inside the body, which will spill onto the paper towels.

Set the syringe body aside on a clean dry surface.

The piston should be fully extended from the pump.

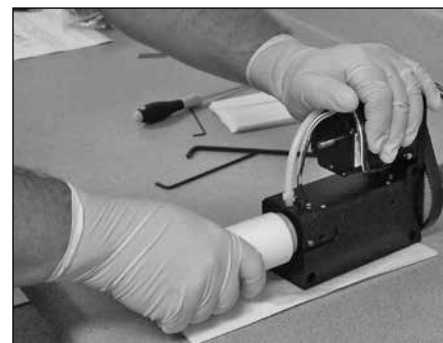

Figure 5-13

PISTON HEAD UNIT DISSASSEMBLY AND SEAL REPLACEMENT

Note: All items to be replaced in the Pump Seal Replacement Procedure can be found in the the Pinnacle Pump Seal Kit (PN 1452-0122).

In the following steps, you will replace 5 items:

- Brass-ended set screw
- Piston Head O-Ring
- Secondary Cylinder O-Ring
- Piston Rod O-Ring
- Three, 4 - 40 x 1/4" capnut screws and washers

Using a 1/16" Alan wrench (do not use ball wrench because it is too weak) remove the set screw from the Piston Head (figure 5-15).

Note: Very Important! Never re-use the set screw. It has a soft brass end that is designed to be used only once. A new set screw is included with the seal kit. Re-use of the set screw can cause the piston head to come loose.

Remove the piston head by turning it in a counter-clockwise direction. It is threaded onto the leadscrew. If needed, use a crescent wrench to loosen the piston head.

Place the piston head on the bench with the PEEK side down. Using a Phillips Head screwdriver, remove the metal plate by removing the 3, 4 - 40 x 1/4" capnuts and washers. These cannot be reused and should be replaced. The piston head will disassemble into 3 parts:

1. Metal Piston Face
2. Piston Head O-ring
3. PEEK Piston Head

Blow out debris from brass-ended set screw that may be inside the piston head. Remove and discard the old O-ring. Sonicate the metal plate, PEEK piston head, and new O-rings in a beaker of water.

Note: Do not over tighten cap screws. Over tightening will strip the threads on the PEEK piston head.

Rinse with DI water and reassemble the Piston Head using the new O-ring and cap screws. Set the reassembled Piston Head Unit aside until Pump Reassembly.

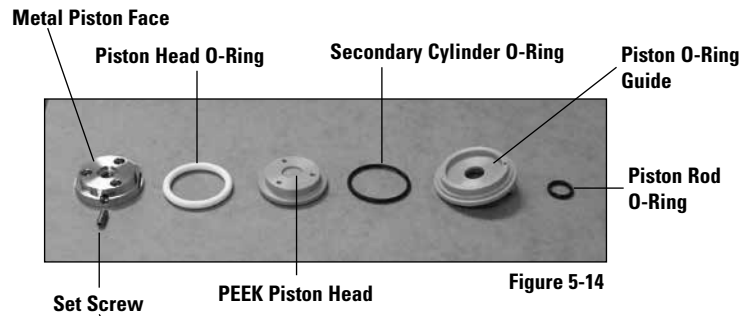

Figure 5-14

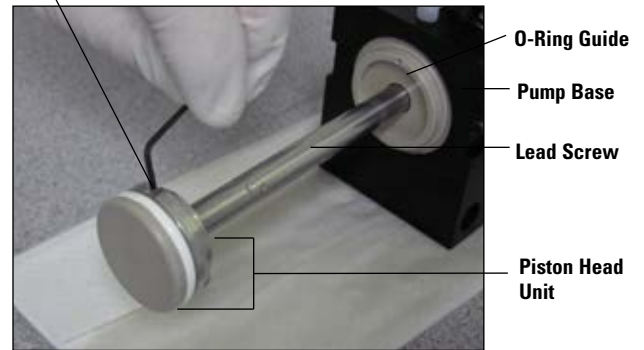

Figure 5-15

SECONDARY O-RING REPLACEMENT

To replace the secondary O-ring at the base of the pump, first remove the piston wash connection and then “back piston” by turning the lead screw 4 to 5 full turns manually. Reverse direction of turn by 4 to 5 full turns by turning the lead screw in the opposite direction. This will extend the O-ring guide at the base of the pump (figure 5-16).

Note: O-ring guide will not come out with piston wash connection still attached.

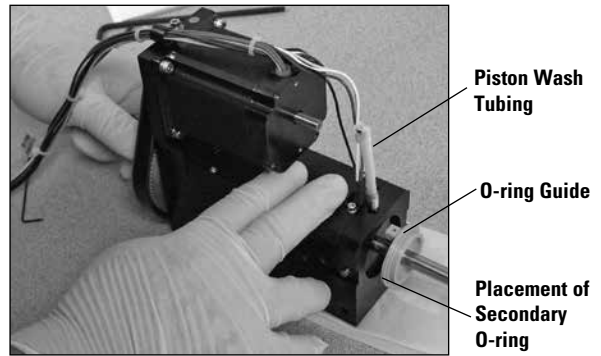

Figure 5-16

Slide the O-ring guide out and replace the small piston rod O-ring that is located at the back of the guide (figure 5-17). Slide the guide back to the base of the pump and replace the large secondary O-ring with the new one (figures 5-14 and 5-16).

PUMP REASSEMBLY

Screw the newly assembled Piston Head Unit onto the head screw (hand tight).

Using a new brass-ended setscrew, tighten the setscrew with the 1/16" Alan wrench. It is important to make this tight.



Figure 5-17

Lubricate the ceramic body with some methanol or isopropanol. Turning it in a clockwise direction, push it back over the piston, using care to keep it horizontal. Ensure that the through holes are orientated top and bottom (figure 5-18).

Place the cylinder cap onto the head of the cylinder and the bracket on the pins, but do not tighten the cap screws. Reference figure 5-12.

The set screw at front of cylinder has “adjustment” depression to center bracket. Center the bracket by sliding it back and forth a little bit until you feel it in the depression. Once it is centered, tighten the set screw. Tighten the set screw so that the syringe is tight against the base of the pump.

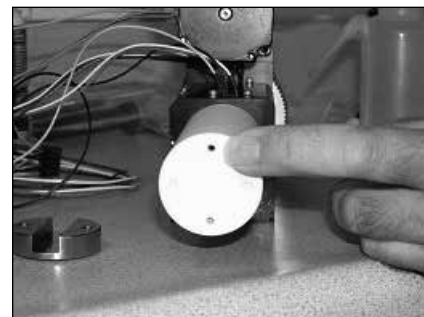

Figure 5-18

Finally, tighten the cap screws using the 3/16" alan wrench.

REPLACE THE PUMP IN THE PINNACLE PCX

Replace the pumps in the Pinnacle PCX by following the reverse of the directions in section titled “To Remove the Pump From Pinnacle PCX” on page 5.12.

Be sure that the body of the pump rests on the support brackets, and that the front of the pump is protruding through the front of the chassis.

Note: Be very careful not to pinch any of the other wires inside this area. Be especially careful of the reactor wires and the valve wires when removing Pump 1.

Attach the reagent and piston wash lines.

FLUSH AND REFILL PUMPS

Turn ON Pinnacle PCX.

Select Control – Flush pump(s). Make sure all flush lines are immersed in solution.

After seals have been exercised for at least 60 minutes, perform Pump and Valve Seal Pressure Test followed by a System Pressure Test. Follow the onscreen instructions.

Fuse Replacement

The fuse is on the back panel under the power switch.

Warning: The Pinnacle PCX must be shutdown to replace the fuse.

Remove the cord from the power inlet.

Use a small flat screwdriver to pry up the fuse holder then pull the fuse out.

Only use the correct type of fuse: 2 ea, 5mm x 20 mm, 5 amp, time lag

Reinstall the fuse holder and the power cord.

1100-0501 Tubing Kit, Pinnacle, Single Pump

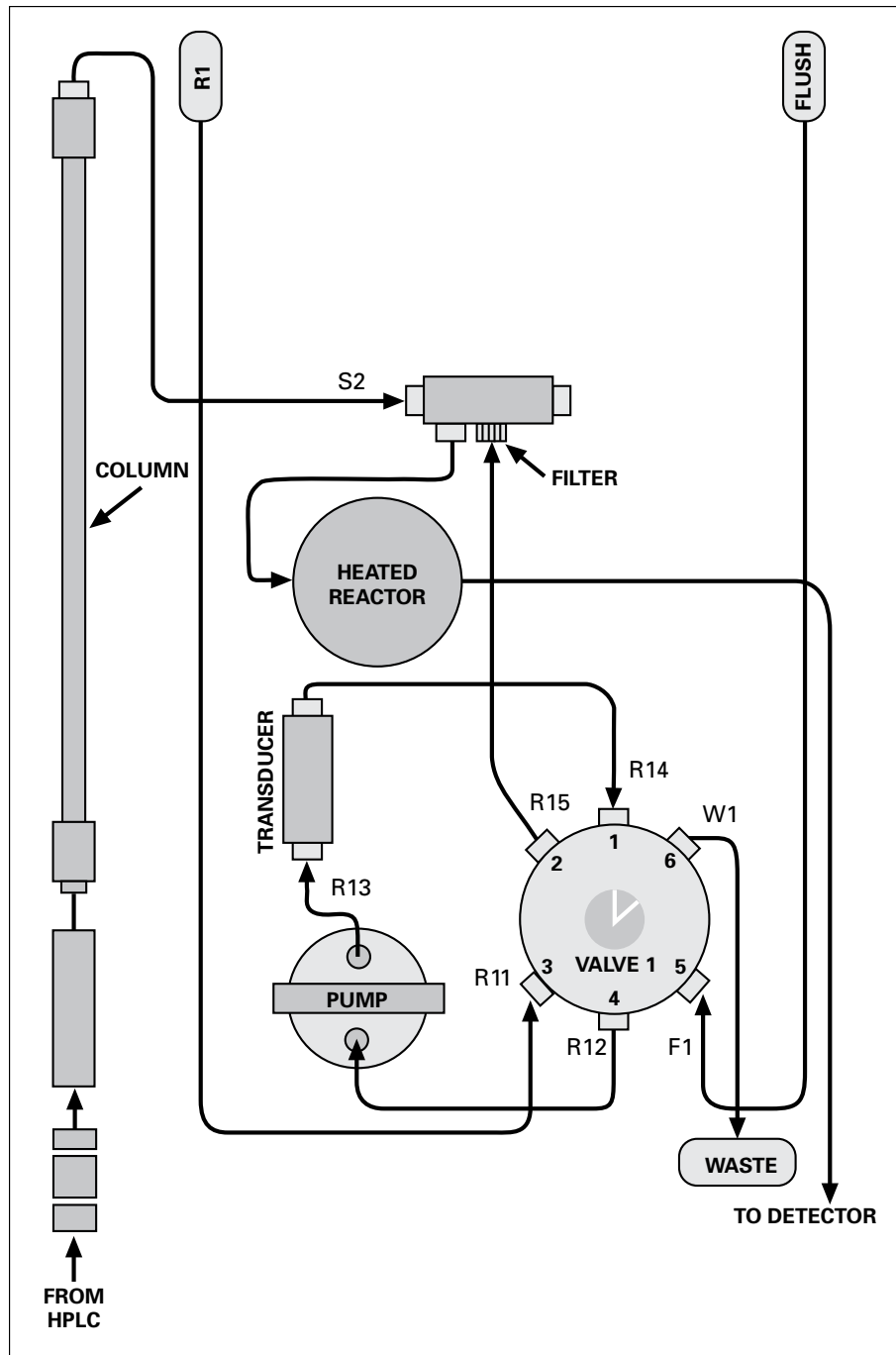

Section 6
APPLICATIONS

- 6.2 AMINO ACIDS**
- 6.3 CARBAMATES**
- 6.4 GLYPHOSATE**

AMINO ACIDS

- 6.2** Introduction
- 6.2-1** Background
- 6.2-2** Basic Sample Preparation
- 6.2-3** Reagent Preparation
- 6.2-4** Analytical and Post-column Conditions
- 6.2-5** Procedure
- 6.2-6** Sample Chromatograms and Gradient Programs
- 6.2-18** Precautions
- 6.2-21** Notes

Introduction

High performance liquid chromatography (HPLC) with post-column derivatization is a technique for rendering analytes more detectable than they would otherwise be in their native forms. Post-column derivatization gives improved sensitivity or better selectivity (reduction of interference) leading to lower detection limits. The Pickering Laboratories Pinnacle PCX was developed to facilitate the determination of amino acids in using sodium ion-exchange or in native samples using lithium ion-exchange columns. There are two options for post-column detection of amino acids. The first is the use of Pickering's patented TRIONE® ninhydrin reagent, which will react with both primary and secondary amino acids. The second is the use of *o*-phthalaldehyde (OPA), a fluorescent reagent that gives greater sensitivity but will detect only primary amino acids.

A complete post-column analysis system for amino acids consists of the following components:

- HPLC ternary or greater gradient pump
- Manual injector or autosampler equipped with high pH compatible Tefzel® or PEEK™ seals
- Pickering Laboratories ion-exchange columns
- Pickering Pinnacle PCX post-column derivatization instrument
- Eluants, reagents, and standards
- Visible or fluorescence detector
- Chart recorder, integrator, or data system

Ion-exchange chromatography followed by post-column derivatization has been the method of choice for amino acid analysis since S. Moore, D.H. Spackman and W.H. Stein published it in 1958—work which merited a Nobel prize.

Background

The separation is a multi-modal process wherein ion-exchange, ion-exclusion, and partition all take place. The primary process is cation-exchange where a pH gradient mobilizes amino acids in order of their isoelectric points; acidic amino acids such as glutamic acid elute early and basic amino acids such as lysine elute late. Partitioning is affected by ionic strength and organic modifiers; for example threonine and serine are resolved by partition effects. Ion-exclusion only occurs for highly acidic amino acids such as taurine.

Sodium ion-exchange is used for fast analysis of the 22 amino acids found in hydrolyzed protein or in simple formulated products. Lithium ion-exchange is a slower technique with higher resolution to separate as many as 46 amino acids and compounds found in the complex mixtures of biological fluids or tissue extracts.

The most popular reagent for post-column detection is ninhydrin. Ninhydrin reacts with primary amines and hydrindantin to form Ruhemann's Purple (Figure 6.2-A) which is detectable at 570nm. Ninhydrin reacts with secondary amines to form a yellow complex detectable at 440nm. The ninhydrin reaction is carried out at 130°C with a reactor volume of 500 µl. The elevated temperature is required because at room temperature, the ninhydrin reaction is very slow and takes hours to go to completion.

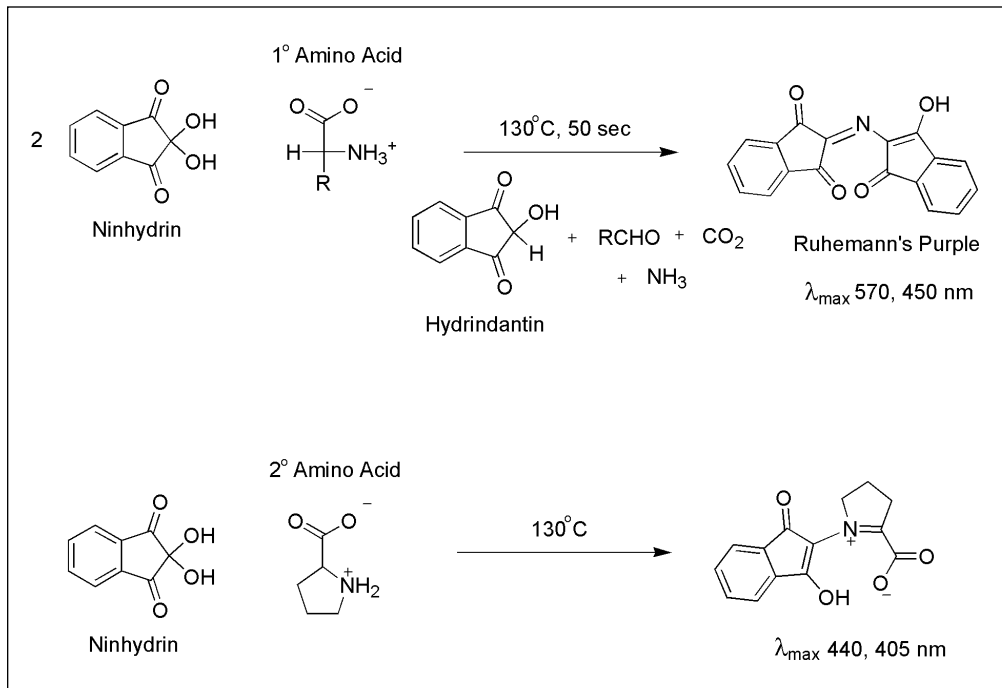

Figure 6.2-A

An alternative reagent system based on *o*-phthalaldehyde (OPA) can be used for high-sensitivity detection of primary amino acids. OPA reacts rapidly with primary amines and Thiofluor™ (N,N-dimethyl-2-mercaptoethylamine) under mild basic conditions to produce a strongly fluorescent isoindole derivative (Figure 6.2-B). OPA does not react with secondary amines or aryl amines, so fails to detect Proline and other secondary amino acids.

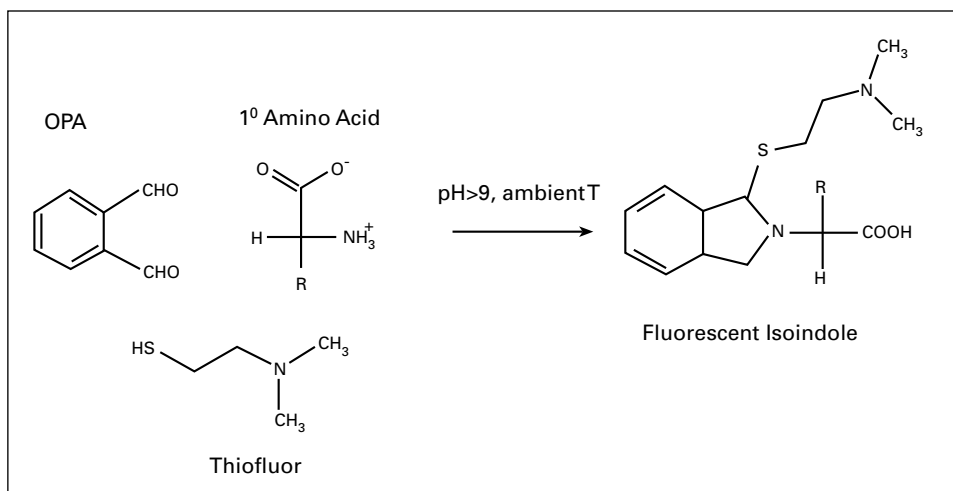

Figure 6.2-B

However, it is possible to detect secondary amino acids by using a two-step reaction in which they are first oxidized and then reacted with OPA. This technique has some disadvantages, and is not often used. Contact Pickering for details.

The Pickering Pinnacle PCX derivatization instrument for fluorescent detection of amino acids is similarly designed to the ninhydrin instrument, except that it contains a 150 μ l reactor and the reaction is carried out at 45°C.

Basic Sample Preparation

The following is a general sample preparation for Physiologic Fluid and Protein Hydrolysate samples. There are many more types of samples that can be used for amino acid analysis. For details, consult the AOAC methods and laboratory procedures.

Native amino acids are those found “free” in samples such as serum, urine and other physiological fluids, plant extracts, foods and beverages. Although preparation of these samples for amino acid analysis is much simpler and less time-consuming than protein hydrolysis, control of pH and normality, and removal of soluble protein are critical factors which can affect the chromatography.

The early-eluting amino acids — taurine, urea, aspartic acid, threonine, serine, etc. — are particularly sensitive to pH and normality. Accordingly the samples must be held to a narrow pH range between 2.1 and 2.5, and the proper lithium ion concentration to ensure reproducibility in the early part of the chromatogram. The later-eluting compounds are more tolerant of initial sample conditions, and their retention times are not as likely to be affected. SERAPREP™ and URIPREP™ replace commonly-used protein precipitation reagents such as acetonitrile, perchloric acid and picric acid, and eliminate the need for dialysis, ultrafiltration, and repeated centrifugation steps, followed by pH adjustment.

- Filter all samples through a 0.45µm membrane filter. Some samples may require even more stringent filtration, especially if colloids are present.
- Samples must always be properly buffered. The ideal pH for sample injection is pH 2.3 ± 0.2 .
- For native samples, be sure that all proteins have been removed before analysis.

PHYSIOLOGIC FLUID SAMPLES:

PREPARATION USING SERAPREP™ OR URIPREP™

Use SERAPREP™ for preparing serum and other samples with a high buffering capacity, e.g. sardine oil. Use URIPREP™ for preparing urine and other samples with low buffering capacity, such as fruit juices, musts and warts. The efficiency of protein precipitation and the need for post-centrifugation pH adjustment of the sample determine which reagent is best for your particular sample.

1. In a microcentrifuge tube thoroughly mix equal portions of sample and SERAPREP™ or URIPREP™.
2. Let stand for 5 minutes. Centrifuge the mixture at 13,000 rpm for 5 minutes. Check the supernate pH to ensure that the range is pH 2.3 ± 0.2 . Adjust the initial mixing ratio as necessary.
3. Filter the supernate with a syringe filter (0.2 or 0.45 µm). The filtrate is ready to be injected into an auto-sampler vial for amino acid analysis.
4. If further dilution is needed, use Li 220 to adjust the concentration of analyte.

Reagent Preparation

TRIONE PREPARATION

TRIONE® reagent requires little to no preparation, depending on what type you use.

T100: The one-part TRIONE® (Cat. No. T100C) requires no preparation - simply pour the TRIONE® directly into the reagent reservoir and put the cap on the reservoir.

T200: To prepare two-part TRIONE® (Cat. No. T200), pour Bottle 1 into the reservoir, add Bottle 2 to the reservoir, and cap tightly under Nitrogen. Swirl until homogeneous.

Note: TRIONE® is air sensitive, and must be kept under Nitrogen. The useful lifetime of T100 is three months* unopened, and one month in the reservoir. The shelf-life of T200 is one year* unmixed, and one month in the reservoir.

*From date of manufacture.

OPA PREPARATION

1. Pour 945ml of the OPA Diluent (Cat.No. OD104) into the reagent reservoir. Save approximately 5 ml for Step 5.
2. Put the cap on the bottle, open the vent valve, and turn on the gas supply. Thoroughly deaerate the contents by sparging with inert gas. Continue bubbling for at least 10 minutes.
3. Dissolve 300mg of OPA (Cat. No. O120) in 10mL of HPLC-grade methanol in a clean, dry container.
4. Turn off the gas supply and remove the cap from the bottle. Add the OPA solution to the deoxygenated diluent in the reservoir. Wash any residual mixture into the reservoir with an additional 1–2 ml of methanol.
5. Dissolve 2g of Thiofluor™ (Cat. No. 3700-2000) in the reserved 5 ml of OPA Diluent and add to the reservoir.
6. Add 3ml of 30% Brij-35® (Sigma) solution.
7. Replace the cap and close the vent valve. Gently swirl the reagent to complete the mixing. Turn on the inert gas.

Note: OPA reagent is sensitive to air oxidation and will degrade over time. The Pinnacle PCX system is designed to minimize this oxidation. When the OPA reagent reservoir is maintained under inert gas pressure, the OPA reagent can maintain its activity for up to one week without significant loss of activity.

Post Column Conditions

These are the recommended post-column conditions for the most common methods of amino acid analysis. For the HPLC conditions, refer to the section titled Sample Chromatograms and Gradient Programs.

USING TRIONE NINHYDRIN REAGENT:

Reagent 1: TRIONE® (Cat. No. T100 or T200)
Pump 1 Flow Rate: 0.30 ml/min
Reactor 1 Volume: 500 µl
Reactor 1 Temp: 130°C

USING OPA REAGENT:

Reagent 1: *o*-Phthalaldehyde and Thiofluor™ in OD104 Diluent, plus 35% Brij-35®
Pump 1 Flow Rate: 0.30 ml/min
Reactor 1 Volume: 150 µl
Reactor 1 Temp: 45°C

USING SODIUM HYPOCHLORITE, FOLLOWED BY OPA REAGENT:

Reagent 1:	250 µl of 5% Sodium Hypochlorite in GA116 Diluent
Reagent 2:	<i>o</i> -Phthalaldehyde and Thiofluor™ in OD104 Diluent, plus 30% Brij-35®
Pump 1 Flow Rate:	0.30 ml/min
Pump 2 Flow Rate:	0.30 ml/min
Reactor 1 Volume:	500 µl
Reactor 2 Volume:	100 µl
Reactor 1 Temp:	55°C
Reactor 2 Temp:	Ambient

Procedure

Pickering Laboratories recommends different gradient conditions depending on the column and type of sample.

Use the program recommended on the column data sheet for the initial testing. Do not change this program until you are sure that the other aspects of the system are functioning properly.

The column oven temperature programming gives additional flexibility when optimizing methods. Using temperature gradient allows to improve separation, shorten analysis time and fine-tune the method for detecting compounds of interest. Please refer to page 4.8 for details on how to set up timetable for the column oven.

Set the maximum pressure limit on the HPLC to 220 bar to protect the column. Allow the column to equilibrate for about 30 minutes under initial conditions. Inject 10µl of the Amino Acid Standard, and collect three chromatograms. The first chromatogram will not be representative of the systems performance, so use the second two to evaluate the performance.

Sample Chromatograms and Gradient Programs

METHOD 1: 0354675T 70-MIN PHYSIOLOGICAL FLUID LITHIUM (4.6 x 75mm)

GUARD COLUMN: GARD

COLUMN TEMP: SEE GRADIENT

HPLC FLOW RATE: 0.55ml/min

REAGENT FLOW RATE: 0.5ml/min

INJECTION VOLUME: 10ul

HPLC PROGRAM				
Time	1700-1125 %	Li365 %	Li375 %	RG003 %
0	100	0	0	0
10	100	0	0	0
19	40	60	0	0
32	0	100	0	0
43	0	100	0	0
43.1	0	0	100	0
57	0	0	100	0
57.1	0	0	70	30
72	0	0	70	30
72.1	100	0	0	0

COLUMN OVEN PROGRAM	
Time	Temp °C
0	34
6	34
17	65
25	70
70	70
71	34

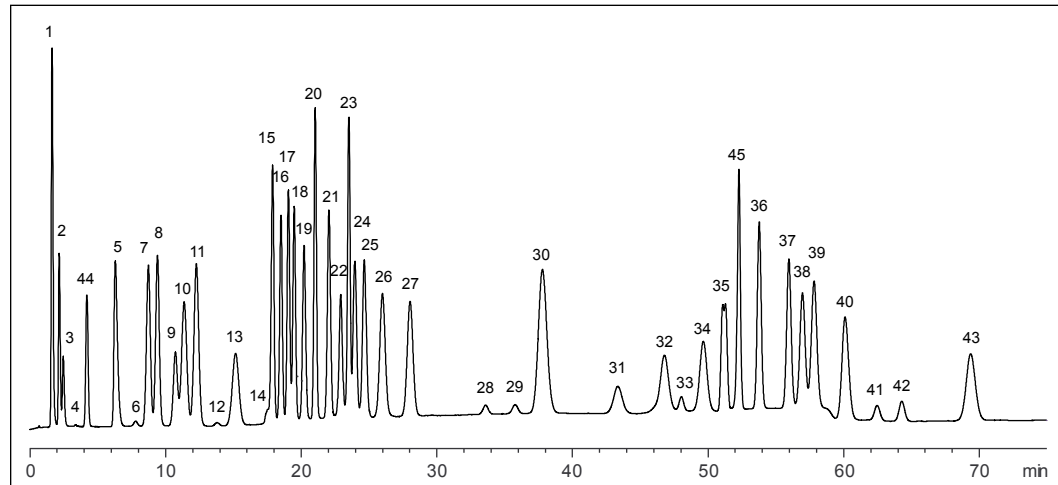

PEAK IDENTIFICATION

1 Phosphoserine	13 -Amino adipic acid	25 Leucine	37 Lysine
2 Taurine	14 Proline	26 Tyrosine	38 1-Methylhistidine
3 Phosphoethanolamine	15 Glycine	27 Phenylalanine	39 Histidine
4 Urea	16 Alanine	28 -Alanine	40 3-Methylhistidine
5 Aspartic acid	17 Citrulline	29 -Amino-i-butyric acid	41 Anserine
6 Hydroxyproline	18 -Amino-n-butyric acid	30 Homocystine	42 Carnosine
7 Threonine	19 Valine	31 -Aminobutyric acid	43 Arginine
8 Serine	20 Cystine	32 Tryptophan	44 Glucosaminic Acid*
9 Asparagine	21 Methionine	33 Ethanolamine	45 2-Aminoethyl-cysteine (AEC)*
10 Glutamic acid	22 Allo-Isoleucine	34 Ammonia	
11 Glutamine	23 Cystathionine	35 Hydroxylysines	
12 Sarcosine	24 Isoleucine	36 Ornithine	

*Internal Standard

NOTE: This method utilizes column temperature gradient. Use Pinnacle PCX column oven or HPLC column oven with temperature gradient capabilities.

METHOD 2: 0354100T ISOTHERMIC PHYSIOLOGICAL FLUID LITHIUM (4.0 x 100mm)
GUARD COLUMN: GARD **COLUMN TEMP: 37°C** **HPLC FLOW RATE: 0.35ml/min**
REAGENT FLOW RATE: 0.3ml/min **INJECTION VOLUME: 10ul**

CONDITIONS				
Time (Min)	Li275 %	Li750 %	RG003 %	Comment
0	100	0	0	Inject
8	100	0	0	Isocratic
46	65	35	0	Linear Gradient
86	0	100	0	Linear Gradient
90	0	100	0	Isocratic
115	0	94	6	Linear Gradient
122	0	94	6	Isocratic
122.1	100	0	0	Step Change
140	100	0	0	Re-equilibration

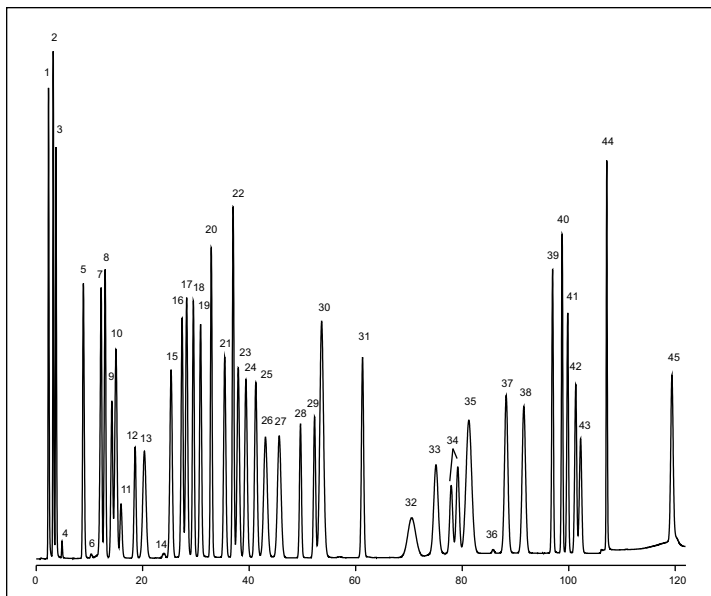

PEAK IDENTIFICATION

- | | | | |
|------------------------|------------------------------------|--|---|
| 1. Phosphoserine | 13. α -Amino adipic acid | 25. Norleucine | 37. Ornithine |
| 2. Taurine | 14. Proline | 26. Tyrosine | 38. Lysine |
| 3. Phosphoethanolamine | 15. Glycine | 27. Phenylalanine | 39. Histidine |
| 4. Urea | 16. Alanine | 28. β -Alanine | 40. 3-Methylhistidine |
| 5. Aspartic acid | 17. Citrulline | 29. β -Amino- γ -butyric acid | 41. 1-Methylhistidine |
| 6. Hydroxyproline | 18. α -Amino-n-butyric acid | 30. Homocystine | 42. Carnosine |
| 7. Threonine | 19. Valine | 31. γ -Aminobutyric acid | 43. Anserine |
| 8. Serine | 20. Cystine | 32. Tryptophan | 44. α -Amino- β -guanidinopropionic acid |
| 9. Asparagine | 21. Methionine | 33. Ethanolamine | 45. Arginine |
| 10. Glutamic acid | 22. Cystathionine | 34. Hydroxylysines | |
| 11. Glutamine | 23. Isoleucine | 35. Ammonia | |
| 12. Sarcosine | 24. Leucine | 36. Creatinine | |

METHOD 3: 0354100T TEMP GRADIENT PHYSIOLOGICAL FLUID LITHIUM (4.0 x 100mm)**GUARD COLUMN: GARD****COLUMN TEMP: SEE GRADIENT****HPLC FLOW RATE: 0.4ml/min****REAGENT FLOW RATE: 0.3ml/min****INJECTION VOLUME: 10ul**

CONDITIONS						COLUMN OVEN PROGRAM	
Time (Min)	1700-1125 %	Li365 %	Li375 %	RG003 %	Comment	Time (Min)	Temp. °C
0	100	0	0	0	Inject	0	34
15	100	0	0	0	Isocratic	13	34
27	40	60	0	0	Linear Gradient	30	65
45	0	100	0	0	Linear Gradient	67	66
60	0	100	0	0	Isocratic	80	70
60.1	0	0	100	0	Step Gradient	97	70
78	0	0	100	0	Isocratic	98	34
78.1	0	0	70	30	Step Gradient		
95	0	0	70	30	Isocratic		
95.1	100	0	0	0	Step Gradient		
115	100	0	0	0	Equilibration		

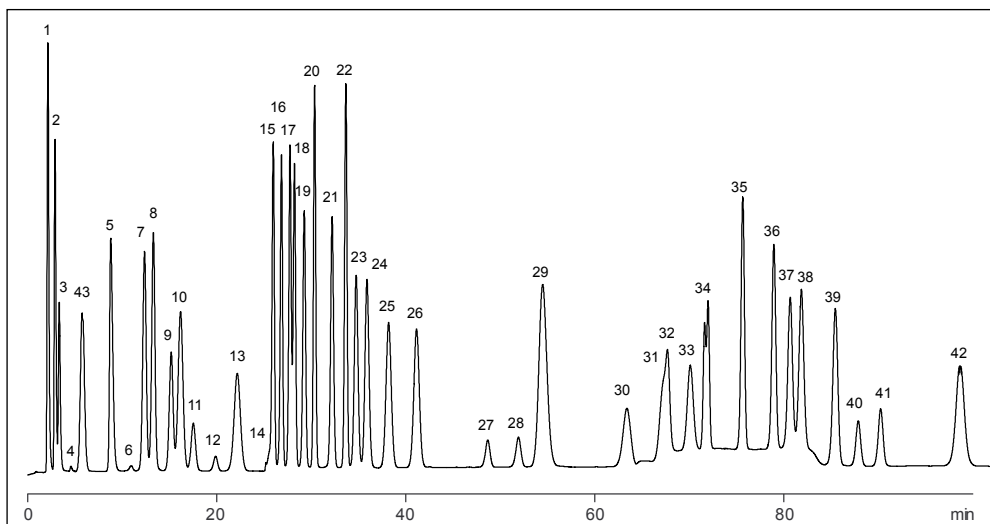
**PEAK IDENTIFICATION**

1 Phosphoserine	12 Sarcosine	23 Isoleucine	34 Hydroxylysines
2 Taurine	13 α -Amino adipic acid	24 Leucine	35 Ornithine
3 Phosphoethanolamine	14 Proline	25 Tyrosine	36 Lysine
4 Urea	15 Glycine	26 Phenylalanine	37 1-Methylhistidine
5 Aspartic acid	16 Alanine	27 β -Alanine	38 Histidine
6 Hydroxyproline	17 Citrulline	28 β -Amino-i-butyric acid	39 3-Methylhistidine
7 Threonine	18 α -Amino-n-butyric acid	29 Homocystine	40 Anserine
8 Serine	19 Valine	30 γ -Aminobutyric acid	41 Carnosine
9 Asparagine	20 Cystine	31 Tryptophan	42 Arginine
10 Glutamic acid	21 Methionine	32 Ethanolamine	43 Glucosaminic Acid*
11 Glutamine	22 Cystathionine	33 Ammonia	

*Internal Standard

NOTE: This method utilizes column temperature gradient. Use Pinnacle PCX column oven or HPLC column oven with temperature gradient capabilities.

METHOD 4: 0393250 ISOTHERMIC PHYSIOLOGICAL FLUID LITHIUM (3.0 x 250mm)

GUARD COLUMN: GARD

COLUMN TEMP: 40°C

HPLC FLOW RATE: 0.30ml/min

REAGENT FLOW RATE: 0.3ml/min

INJECTION VOLUME: 10ul

Time(min)	%Li275	%Li750	%RG003	Comment
0	100	0	0	inject
17	100	0	0	isocratic
65	65	35	0	linear gradient
128	0	100	0	linear gradient
145	0	100	0	isocratic
185	0	94	6	linear gradient
185.1	100	0	0	step change
210	100	0	0	re-equilibration

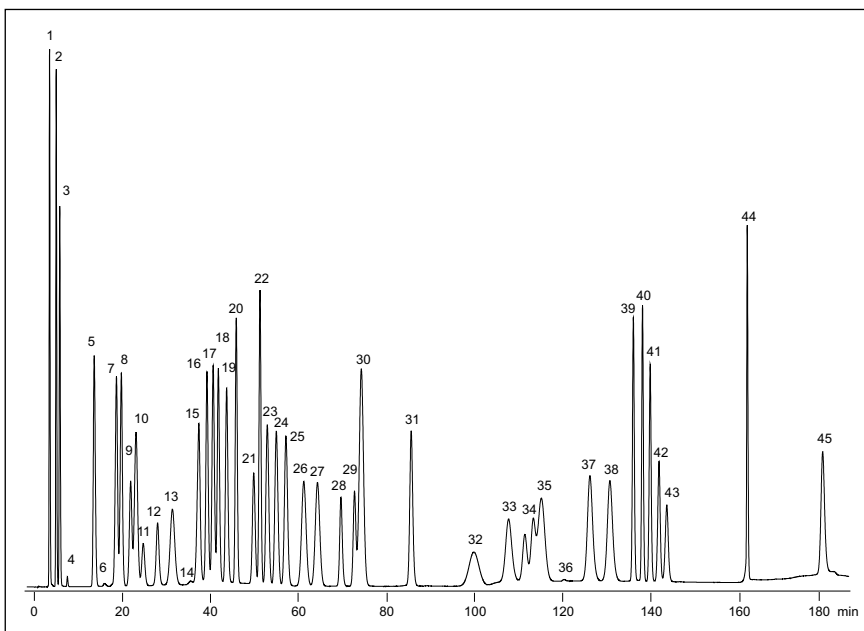

PEAK IDENTIFICATION

- | | | | |
|------------------------|------------------------------------|-----------------------------------|---|
| 1. Phosphoserine | 13. α -Amino adipic acid | 25. Norleucine | 37. Ornithine |
| 2. Taurine | 14. Proline | 26. Tyrosine | 38. Lysine |
| 3. Phosphoethanolamine | 15. Glycine | 27. Phenylalanine | 39. Histidine |
| 4. Urea | 16. Alanine | 28. β -Alanine | 40. 3-Methylhistidine |
| 5. Aspartic acid | 17. Citrulline | 29. β -Amino-i-butyrac acid | 41. 1-Methylhistidine |
| 6. Hydroxyproline | 18. α -Amino-n-butyrac acid | 30. Homocystine | 42. Carnosine |
| 7. Threonine | 19. Valine | 31. γ -Aminobutyric acid | 43. Anserine |
| 8. Serine | 20. Cystine | 32. Tryptophan | 44. α -Amino- β -guanidinopropionic acid |
| 9. Asparagine | 21. Methionine | 33. Ethanolamine | 45. Arginine |
| 10. Glutamic acid | 22. Cystathionine | 34. Hydroxylysines | |
| 11. Glutamine | 23. Isoleucine | 35. Ammonia | |
| 12. Sarcosine | 24. Leucine | 36. Creatinine | |

METHOD 5: 0354100T PKU AND MSUD SCREENING LITHIUM (4.0 x 100mm)**GUARD COLUMN: GARD****COLUMN TEMP: 38°C****HPLC FLOW RATE: 0.35ml/min****REAGENT FLOW RATE: 0.3ml/min****INJECTION VOLUME: 10ul**

Time (min)	%Li275	%Li750	%RG003	Comment
0	86	14	0	Inject
25	73	27	0	Linear gradient
25.1	0	0	100	Step gradient
30	0	0	100	Isocratic
30.1	86	14	0	Step gradient
42	86	14	0	Re-equilibration

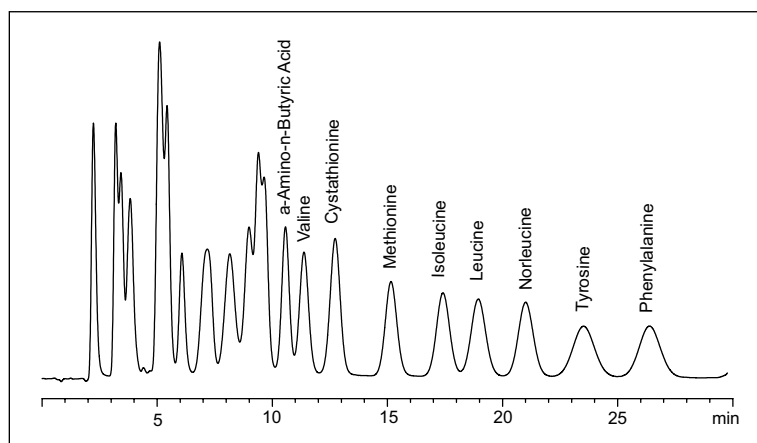

METHOD 6: 1154110T OXIDIZED HYDROLYSATE SODIUM (4.6X110 MM)

GUARD COLUMN: GARD

COLUMN TEMP: SEE GRADIENT

HPLC FLOW RATE: 0.6ml/min

REAGENT FLOW RATE: 0.3ml/min

INJECTION VOLUME: 10ul

HPLC PROGRAM				
Time	% Na270	% Na425	% Na640	% RG011
0	100	0	0	0
4.0	100	0	0	0
15.0	0	100	0	0
16.0	0	0	100	0
31.0	0	0	100	0
31.1	0	0	0	100
33.0	0	0	0	100
33.1	100	0	0	0
40	100	0	0	0

COLUMN OVEN PROGRAM	
Time	Temp °C
0	55
12	55
17	70
32	70
33	55

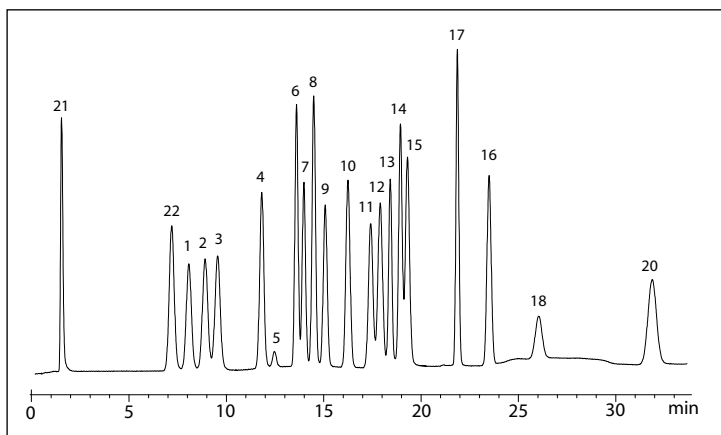

PEAK IDENTIFICATION

- | | | |
|-----------------|------------------|------------------------------|
| 1 Aspartic Acid | 10 Methionine | 19 Tryptophan |
| 2 Threonine | 11 Isoleucine | 20 Arginine |
| 3 Serine | 12 Leucine | 21 Cysteic Acid |
| 4 Glutamic Acid | 13 Norleucine | 22 Methionine Sulfone |
| 5 Proline | 14 Tyrosine | 23 Methionine Sulfoxide |
| 6 Glycine | 15 Phenylalanine | 24 Trans-4-Hydroxy-L-Proline |
| 7 Alanine | 16 Lysine | 25 D,L & allo-Hydroxylysine |
| 8 Cystine | 17 Histidine | |
| 9 Valine | 18 Ammonia | |

*NOTE: This method utilizes column temperature gradient.
Use Pinnacle PCX column oven or HPLC column oven with
temperature gradient capabilities.*

METHOD 7: 1154110T PROTEIN HYDROLYSATE SODIUM (4.6X110 MM)**GUARD COLUMN: GARD****COLUMN TEMP: SEE GRADIENT****HPLC FLOW RATE: 0.6ml/min****REAGENT FLOW RATE: 0.3ml/min****INJECTION VOLUME: 10ul**

HPLC PROGRAM				
Time	% Na315	% Na425	% Na640	% RG011
0	100	0	0	0
4.0	100	0	0	0
15.0	0	100	0	0
16.0	0	0	100	0
31.0	0	0	100	0
31.1	0	0	0	100
33.0	0	0	0	100
33.1	100	0	0	0
40	100	0	0	0

COLUMN OVEN PROGRAM	
Time	Temp °C
0	46
4	46
9	70
32	70
33	46

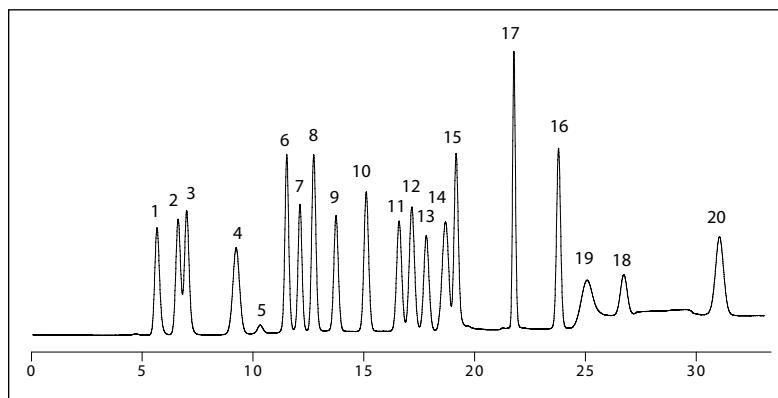

METHOD 8: 1154110T COLLAGEN HYDROLYSATE SODIUM (4.6X110 MM)**GUARD COLUMN: GARD****COLUMN TEMP: SEE GRADIENT****HPLC FLOW RATE: 0.6ml/min****REAGENT FLOW RATE: 0.3ml/min****INJECTION VOLUME: 10ul**

HPLC PROGRAM				
Time	% Na315	% Na425	% Na640	% RG011
0	100	0	0	0
4.0	100	0	0	0
15.0	0	100	0	0
16.0	0	0	100	0
31.0	0	0	100	0
31.1	0	0	0	100
33.0	0	0	0	100
33.1	100	0	0	0
40	100	0	0	0

COLUMN OVEN PROGRAM	
Time	Temp °C
0	42
4	42
9	70
32	70
33	42

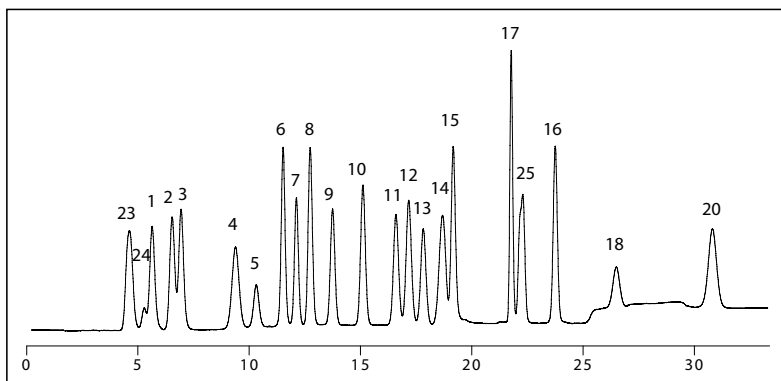

METHOD 10: 1154150T ISOTHERMIC PROTEIN AND COLLAGEN HYDROLYSATE SODIUM (4.0 x 150mm)
GUARD COLUMN: GARD **COLUMN TEMP: 48°C** **HPLC FLOW RATE: 0.4ml/min**
REAGENT FLOW RATE: 0.3ml/min **INJECTION VOLUME: 10ul**

CONDITIONS FOR PROTEIN & COLLAGEN HYDROLYSATE SAMPLES			
Time (Min)	Na315 %	Na740 %	RG011 %
0	100	0	0
10	100	0	0
30	0	100	0
53	0	100	0
53.1	0	0	100
55	0	0	100
55.1	100	0	0
67	100	0	0

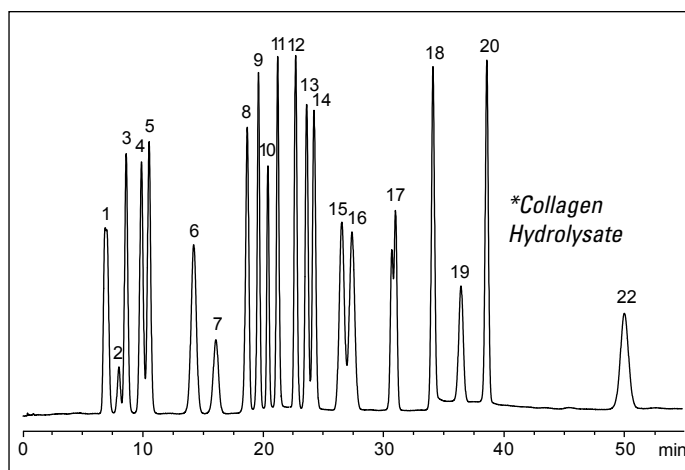
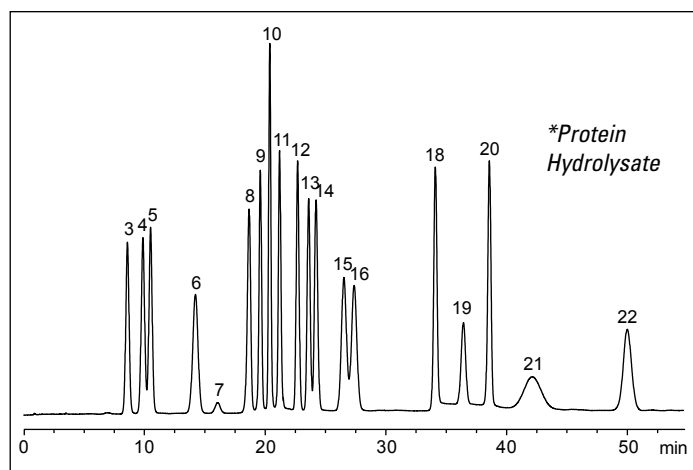

PEAK IDENTIFICATION

1	Methionine-D,L,-Sulfoxide	13	Isoleucine
2	trans-4-Hydroxy-L-Proline	14	Leucine
3	Aspartic Acid	15	Tyrosine
4	Threonine	16	Phenylalanine
5	Serine	17	D,L & allo-Hydroxylysine
6	Glutamic Acid	18	Lysine
7	Proline	19	Ammonia
8	Glycine	20	Histidine
9	Alanine	21	Tryptophan
10	Cystine	22	Arginine
11	Valine		
12	Methionine		

METHOD 11: 1154150 ISOTHERMIC PROTEIN AND COLLAGEN HYDROLYSATE SODIUM (4.0 x 150mm)
GUARD COLUMN: GARD **COLUMN TEMP: 48°C** **HPLC FLOW RATE: 0.40ml/min**
REAGENT FLOW RATE: 0.3ml/min **INJECTION VOLUME: 10ul**

Time(min)	%1700-0112*	%Na740	%RG011	Comment
0	100	0	0	inject
12	100	0	0	isocratic
34	0	100	0	linear gradient
53	0	100	0	isocratic
53.1	0	0	100	step gradient
55	0	0	100	isocratic
55.1	100	0	0	isocratic
67	100	0	0	re-equilibration

Collagen Hydrolysate

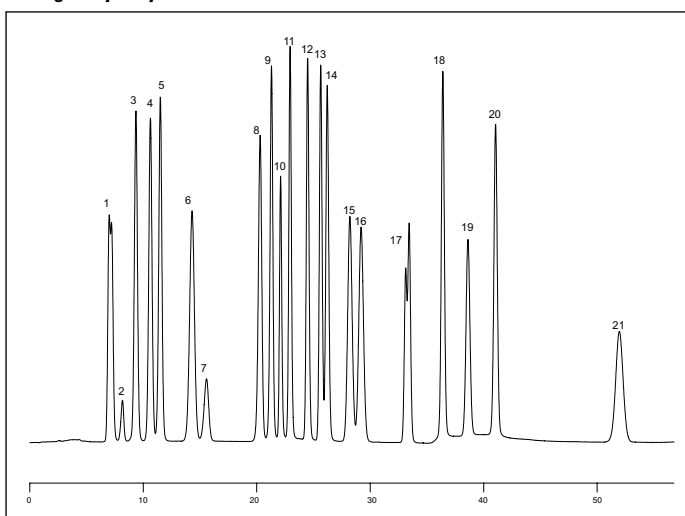

Protein Hydrolysate

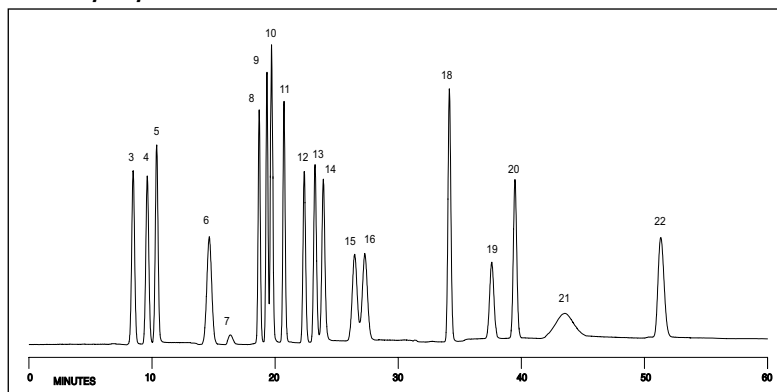

* For use with columns with serial numbers after 1314

METHOD 12: 1193250 ISOTHERMIC PROTEIN HYDROLYSATE SODIUM (3.0 x 250mm)

GUARD COLUMN: GARD

COLUMN TEMP: 48°C

HPLC FLOW RATE: 0.30ml/min

REAGENT FLOW RATE: 0.3ml/min

INJECTION VOLUME: 10ul

Time(min)	%Na328	%Na740	%RG011	Comment
0	100	0	0	inject
10	100	0	0	isocratic
32	0	100	0	linear gradient
56	0	100	0	isocratic
56.1	0	0	100	step gradient
58	0	0	100	isocratic
58.1	100	0	0	step change
70	100	0	0	re-equilibration

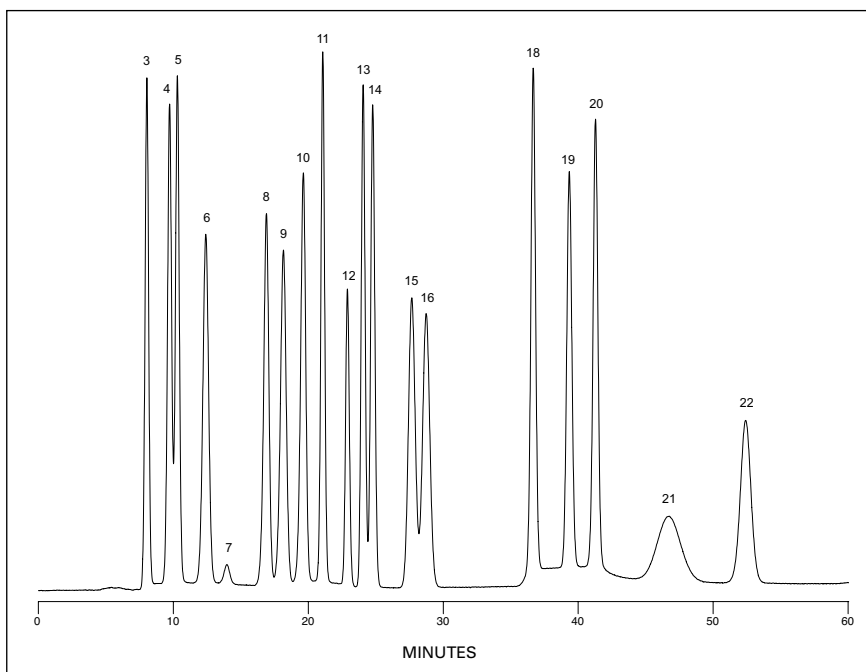

PEAK IDENTIFICATION

- | | | | |
|-------------------------|----------------|--------------------|------------------------|
| 1. Methionine sulfoxide | 8. Glycine | 15. Tyrosine | 22. Arginine |
| 2. Hydroxyproline | 9. Alanine | 16. Phenylalanine | 23. Cysteic acid |
| 3. Aspartic acid | 10. Cystine | 17. Hydroxylysines | 24. Methionine Sulfone |
| 4. Threonine | 11. Valine | 18. Lysine | 25. Norleucine |
| 5. Serine | 12. Methionine | 19. Ammonia | |
| 6. Glutamic acid | 13. Isoleucine | 20. Histidine | |
| 7. Proline | 14. Leucine | 21. Tryptophan | |

Precautions for Amino Acid Analysis

Use Pickering Laboratories reagents and eluants. The quality of the chemicals is excellent, and the cost is low relative to the worth of your analytical results.

Use the Pickering column and eluants. They are designed to work together.

Use the proper start-up and shutdown procedures consistently (see Chapter 2 and 4).

Avoid touching the interior of the mobile phase reservoirs and the dip tubes with your skin. Amino acids in fingerprints will cause contamination. Gloves are suggested.

When switching a system between ion-exchange and reversed-phase applications, be sure to flush the HPLC and injector with water before connecting the column. Eluants for one analysis may damage the column for the other.

Always protect the analytical column by use of the guard column. Always filter the samples through 0.45 μ m filter before injecting.

Daily check for leaks at the column fittings; the eluants can be corrosive.

Do not operate with a column pressure above 2800 psi (193 bars) for an extended period of time. Isolate the source of the high pressure—guard column, analytical column, or in-line filter (if in use) — and replace items causing the increased back pressure.

Note: Back-pressure from filter and guard column should be < 36 bars.

During shutdown, flush the column with regenerant for 15–20 min. Store the column in regenerant.

When removing the column, rinse the end-fittings with water then plug the column to prevent corrosion.

Contamination usually occurs on the guard column first. Wash it separately from the analytical column. This will save much time in the washing and re-equilibration.

Contaminants to be especially wary of: iron and other polyvalent cations, organic dyes, lipids, surfactants, and detergents. These may cause irreversible damage.

Organic solvents will cause the resin in the column to swell leading to high back-pressure and broadened peaks. The column sometimes can be regenerated.

Always wear gloves during the preparation of the reagents. The OPA and Thiofluor™ can cause skin irritation. Also fingerprints can cause contamination of the reagent. TRIONE® will stain skin.

The OPA reagent is sensitive to air oxidation, degrades over time, and should be prepared fresh for optimum sensitivity. OPA reagent is stable for at least one week when pressurized with inert gas.

Thiofluor™ is extremely hygroscopic. Always keep in a tightly closed container.

The preparation of the OPA Diluent by the user is not recommended because sodium borate (any grades) contains excessive amounts of heavy metal contaminants and insoluble matter. These impurities will eventually precipitate in the reactor and flowcell. The one year warranty does not cover damage caused by these contaminants.

The pre-mixed TRIONE® has a shelf life of 3 months*. As it ages, the risk of precipitate formation increases. Using outdated TRIONE® is a major cause of clogging in post-column systems.

Never put new Trione in the bottle containing old reagent. This will cause premature aging of reagent. Always discard old reagent and clean the bottle before putting new TRIONE® in.

As TRIONE® ages, the color intensity for primary amines increases by up to 20%. A small drop in sensitivity when changing to a new lot of TRIONE® is not unusual.

Air oxidation of TRIONE® causes the intensity for primary amines to decrease, but does not affect the intensity for secondary amines. This makes secondary amines appear bigger. Also the reagent becomes more yellow when it is oxidized.

Frequently observe and record the pressures and check for leaks. You may find a problem before it becomes serious.

Do not operate the heated reactor above the boiling point of the eluant unless the back-pressure regulator is connected to the waste line of the detector. Boiling inside the reactor can cause precipitates to block the reactor. Operating above the boiling point without a back pressure regulator will void your warranty.

Note: Before making any change in the gradient, temperature, or other operating conditions, get at least two chromatograms in a row with the same problem. After you make a change, get at least two chromatograms showing the same effect of the change. This is especially true when you are trying to optimize gradient conditions.

Make only one small change at a time.

Make a change only after you have collected at least two chromatograms showing the same separation. This usually means three injections, as the first injection of a series rarely is representative of the rest of the series. Optimize the separations in the early part of the gradient before optimizing the late part.

Every model of HPLC forms gradients differently. The programs suggested in this manual or in the information sheets are typical of the more popular HPLC pumps. Consult Pickering Laboratories if you need advice. If you need only the early part of the chromatogram, you can save time by truncating the gradient. Go to the final concentration of regenerant and hold it until the most basic component (arginine) elutes, then re-equilibrate with the initial buffer.

The separation is temperature sensitive. Adjusting the temperature may improve it. For example, the resolution of threonine and serine improves when the column temperature is cooler, however the resolution of tyrosine and phenylalanine is best when the column temperature is warmer.

Surfactants, dyes, ninhydrin, and lipids usually cannot be removed. Prevention is the only cure.

Notes

Notes

CARBAMATES

- 6.3 Introduction
- 6.3 Background
- 6.3-2 Basic Sample Preparation
- 6.3-3 Reagent Preparation
- 6.3-5 Post-column Conditions
- 6.3-5 Analytical Procedure
- 6.3-5 Sample Chromatograms and Gradient Programs
- 6.3-12 Precautions
- 6.3-13 Notes

Introduction

High-performance liquid chromatography (HPLC) with post-column derivatization is a technique for rendering analytes more detectable than they would otherwise be in their native forms. Post-column derivatization can give improved sensitivity or better selectivity (reduction of interference) leading to lower detection limits.

The Pickering Laboratories Pinnacle PCX was developed to facilitate the determination of carbamate insecticides, meeting or exceeding performance requirements of U.S. Environmental Protection Agency (USEPA) Method 531.1/531.2, and the AOAC International Protocol 29.A05:

- High sensitivity: detection limits of 0.1–0.5ng (or 0.2–1ppb levels for drinking water) can be routinely achieved.
- Selectivity (specificity): only N-methylcarbamates and N-methyl carbamoyloximes plus components reactive to OPA under the specified operating conditions are detected.
- Minimum sample preparation: drinking water can be directly injected into the HPLC after filtration. No pre-extraction or sample cleanup is required.
- The analysis is easily automated for unattended analyses with the addition of an autosampler.

There are a number of carbamate pesticide compounds employed worldwide which are not included in the 11 compounds mandated by USEPA Method 531.1/531.2 and AOAC Protocol 29.A05. The Pickering Laboratories Carbamate column can separate as many as 23 compounds.

Background

Carbamates, a class of highly effective commercial insecticides, are used worldwide to protect crops from insect pests. Applied directly to food crops such as grains, fruit, and vegetables, carbamates may seep into drinking water sources through agricultural runoff. In addition, if food crops are harvested too soon after application,

residues of carbamates and their by-products may remain in the produce. The use of carbamate insecticides has created a requirement for a simple, reliable, and sensitive method of residue analysis for these compounds found in vegetable matter, drinking water, and industrial waste-water. The USEPA Methods 531.2 and 531.1, and the AOAC International protocol 29.A05, describe a direct-inject method which employs gradient liquid chromatography with fluorescence detection, accomplished by post-column hydrolysis and derivatization of the eluted carbamates.

The general structure of the carbamate insecticides is an N-methyl substituted urethane with the variation in the ester moiety. The structural formulas are shown in Figure 6.3-A.

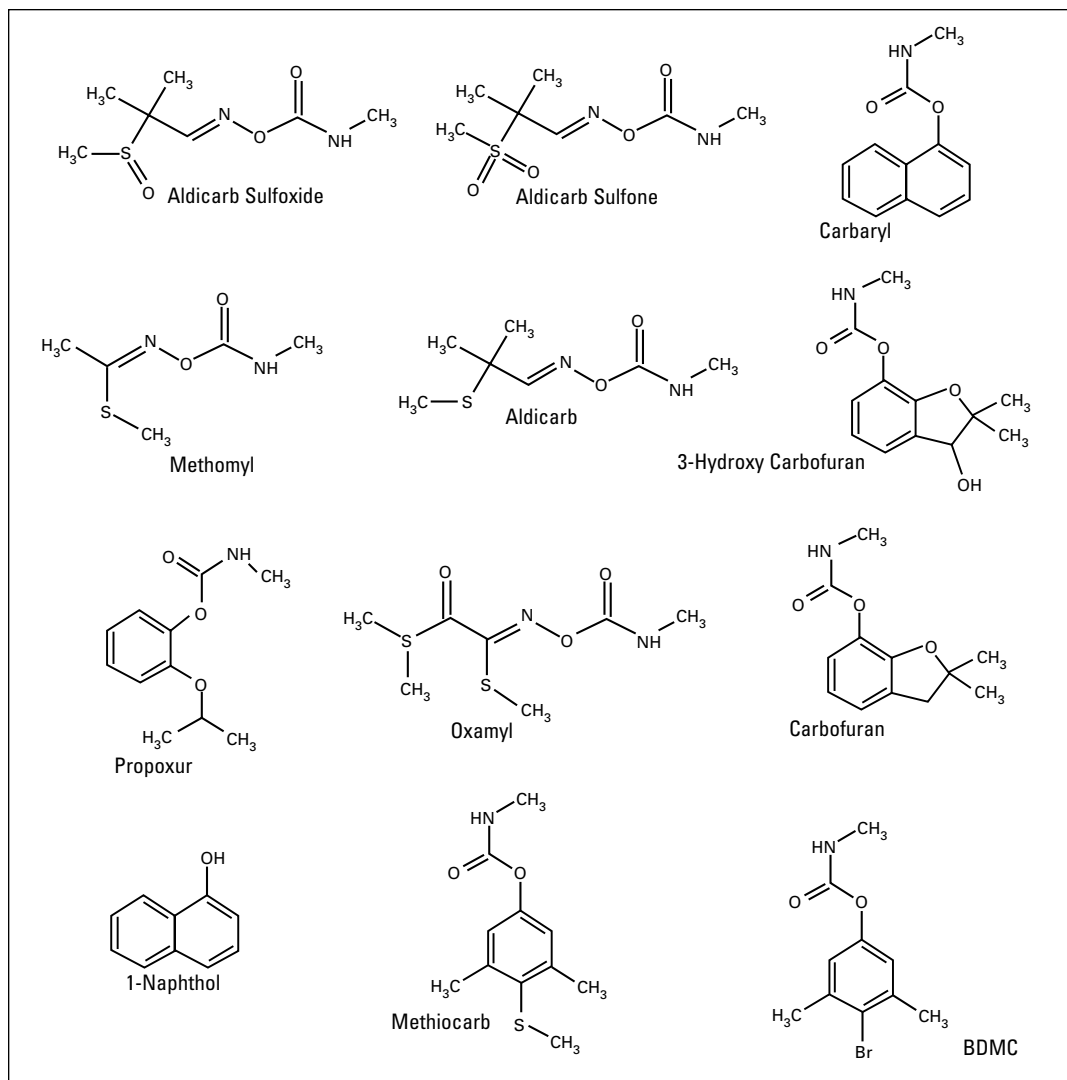

Figure 6.3-A

The separation of the 12 carbamates shown in Figure 6.3-A is achieved with the Pickering Carbamate Column maintained at constant temperature and a water/methanol gradient. The carbamates elute principally in relation to their relative hydrophobicity. Aldicarb sulfone, which is minimally hydrophobic, elutes early while methiocarb, which is more hydrophobic, elutes towards the end of the gradient.

The separated carbamates are first hydrolysed by sodium hydroxide (NaOH) at 100°C to release an alcohol, carbonate, and methylamine. In the second post-column reaction, methylamine reacts with o-phthalaldehyde (OPA) and the nucleophilic Thiofluor™ to form a highly fluorescent isoindole derivative (Figure 6.3-B).

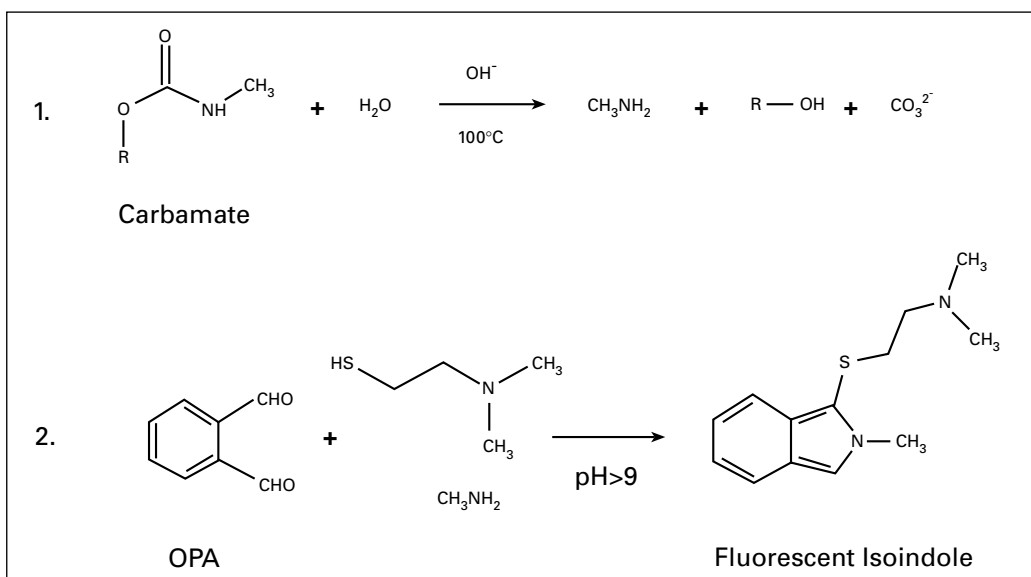

Figure 6.3-B

Note: 1-naphthol fluoresces without derivatization and the hydrolysis of carbaryl in the post-column reactor also produces 1-naphthol, but at a different retention time. This observation is useful for troubleshooting.

Basic Sample Preparation

The following is a general sample preparation for Water samples containing carbamate. For details, consult the EPA 531.2 method for drinking water and the AOAC method for Vegetables.

FOR WATER SAMPLES***Sampling Protocol***

To preserve the Carbamates in water, this procedure should be carried out in the field.

SAMPLING PROTOCOL for EPA Method 531.1 and 531.2

1. Add 1.8 ml of ChlorAC Buffer to each pre-cleaned 60 ml sample vial (see note about well and river waters!)
2. If the water sample is chlorinated, dechlorinate with 5 mg of Sodium thiosulfate per 60 ml sample.
3. Fill the sample vials with the dechlorinated water, seal, and mix well.
4. Refer to method EPA 531 or 531.2 for sample transportation and storage details.

Sample Preparation

Filter 2ml of sample through a 0.45m filter.

Inject 200-400l.

FOR STANDARDS AND BLANKS

Use 10 ml ChlorAC Buffer diluted to 1000 ml with HPLC-grade water.

Note: Well and river waters contain colloidal iron which would dissolve if samples are preserved prior to filtration only to precipitate out again as the hydroxide in the reactor. For well and river waters, it is recommended to filter the water first through a 0.45m filter, and then preserve with ChlorAC™.

Reagent Preparation

The two derivatization reagents required for carbamate analysis are a hydrolysis reagent (NaOH) and *o*-phthalaldehyde reagent.

Note: During initial installation, the reagent bottles, lines, and pump should first be cleaned and primed with methanol to reduce possible fluorescence background.

REAGENT 1, HYDROLYSIS REAGENT

Turn off the inert gas.

Thoroughly wash the two reagent reservoirs and then rinse with methanol. Wipe down the dip tubes with methanol and a clean cellulose tissue.

The hydrolysis reagent does not require preparation. Pour the hydrolysis reagent (Cat. No. CB130 or CB130.2) directly into the reagent reservoir for Reagent 1. It should be labeled Hydrolysis Reagent. Put the cap on the reservoir. Close the vent valve.

The Hydrolysis reagent remains stable indefinitely.

Note: The preparation of the Hydrolysis Reagent by the user is not recommended because it is hard to obtain NaOH of adequate purity.

REAGENT 2, OPA REAGENT

1. Pour 945ml of the OPA Diluent (Cat. No. CB910) into the reagent reservoir. Save approximately 5ml for step 5.
2. Put the cap on the bottle, open the vent valve, and turn on the gas supply. Thoroughly de-aerate the contents by sparging with inert gas. Continue bubbling for at least 10 minutes
3. Dissolve 100 mg of OPA (Cat. No. O120) in approximately 10 ml of HPLC-grade methanol in a clean, dry container.
4. Turn off the gas supply and remove the cap from the bottle. Add the OPA solution to the deoxygenated Diluent in the reservoir.
5. Dissolve 2 g of Thiofluor™ (Cat. No. 3700-2000) in the reserved 5 ml of the OPA diluent from Step 1 and add into the reservoir.
6. Replace the cap and turn on the gas flow. Continue sparging for another minute. Close the vent valve. Gently swirl the reagent to complete the mixing.

Note: The preparation of the OPA Diluent by the user is not recommended because sodium borate (any grades) contains excessive amounts of heavy metal contaminants and insoluble matter. These impurities will eventually precipitate in the reactor and flowcell. The one year warranty does not cover damage caused by these contaminants.

The OPA reagent is sensitive to air oxidation and degrades over time. When the OPA reagent reservoir is maintained under inert gas pressure, the OPA reagent maintains its activity for one week without significant loss of activity.

Post-column Conditions

These are the recommended post-column conditions for carbamate analysis. For the HPLC conditions, refer to the section titled Sample Chromatograms and Gradient programs.

Reagent 1: CB130 or CB130.2, Hydrolysis Reagent (NaOH)
Reagent 2: *o*-Phthalaldehyde and Thiofluor™ in CB910 Diluent
Pump 1 Flow Rate: 0.30 ml/min
Pump 2 Flow Rate: 0.30 ml/min
Reactor 1 Volume: 500 µl
Reactor 2 Volume: 100 µl
Reactor 1 Temp: 100°C
Reactor 2 Temp: Ambient

Analytical Procedure

Allow the column to equilibrate for about 20 minutes under initial conditions.

Inject 10µl of Carbamate Test Mixture (or the appropriate volume of your standard), and collect the first chromatogram.

Sample Chromatograms and Gradient Programs

The Peak Names apply to all chromatograms in this section.

- | | |
|---------------------------------|----------------------------|
| 1. Aldicarb sulfoxide (Standak) | 7. Propoxur (Baygon) |
| 2. Aldicarb sulfone | 8. Carbofuran (Furadan) |
| 3. Oxamyl (Vydate) | 9. Carbaryl (Sevin) |
| 4. Methomyl (Lannate) | 10. 1-Naphthol |
| 5. 3-Hydroxy carbofuran | 11. Methiocarb (Mesurool) |
| 6. Aldicarb (Temik) | 12. BDMC internal standard |

METHOD 1: 0840250 C₈ COLUMN (4.0X250MM) WATER/METHANOL GRADIENT WITH METHANOLIC AND AQUEOUS SAMPLES**HPLC FLOW RATE: 0.8ML/MIN****COLUMN TEMPERATURE: 50° C****REAGENT FLOW RATE: 0.3ML/MIN**

CONDITIONS FOR WATER/METHANOL GRADIENT		
Time (Min)	Water %	MeOH %
0	85	15
2	85	15
42	30	70
46	30	70
46.1	0	100
51	0	100
51.1	85	15
59	85	15

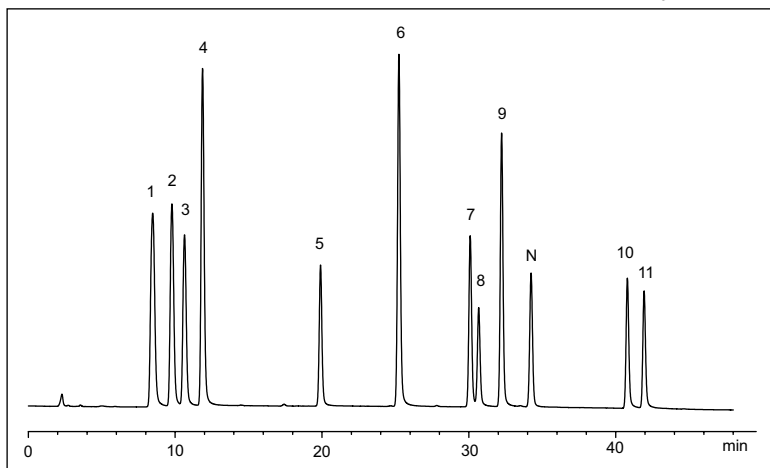
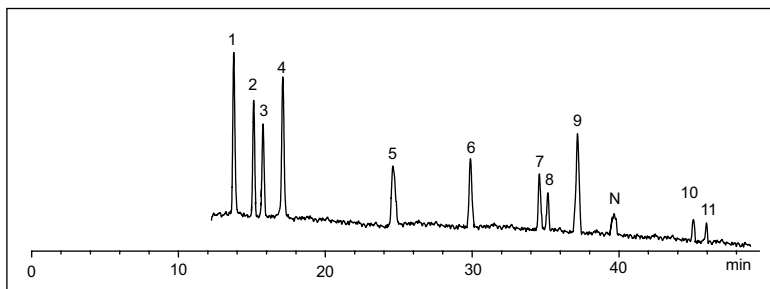
Carbamate Test Mix, 2.5ppm, 10ul injection, 25cm, Carbamate C₈ column (0840250)Carbamate Test Mix, 0.25ppb, 100ul injection, 25cm, Carbamate C₈ column (0840250)

METHOD 2: 0840250 C₈ COLUMN (4.6X110 MM) WATER/ACETONITRILE GRADIENT WITH METHANOLIC AND AQUEOUS SAMPLES**COLUMN TEMP: 50 °C****HPLC FLOW RATE: 0.8ML/MIN****REAGENT FLOW RATE: 0.3ML/MIN**

CONDITIONS FOR WATER/ACETONITRILE GRADIENT		
Time (Min)	Water %	ACN %
0	90	10
2	90	10
46	49	51
46.1	30	70
49	30	70
49.1	90	10
59	90	10

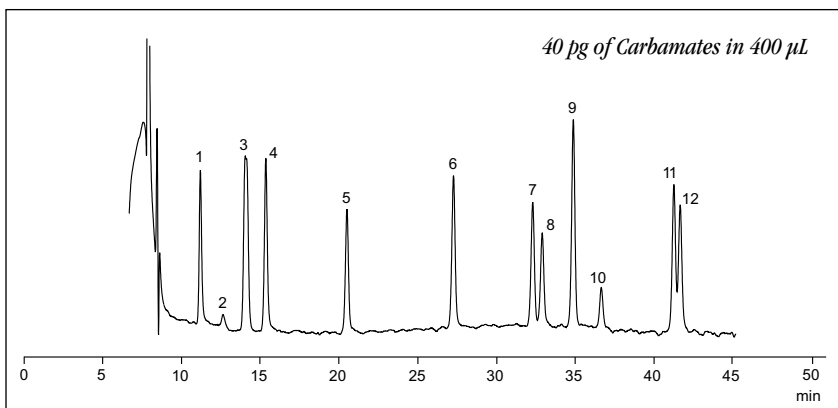

1. Aldicarb sulfoxide
2. Aldicarb sulfone
3. Oxamyl
4. Methomyl

5. 3-Hydroxycarbofuran
6. Aldicarb
7. Propoxur
8. Carbofuran

9. Carbaryl
10. 1-Naphthol
11. Methiocarb
12. BDMC (internal standard)

METHOD 3: 1846150 C₁₈ COLUMN (4.6X150MM) WITH METHANOLIC SAMPLES
HPLC FLOW RATE: 1.0ML/MIN COLUMN TEMPERATURE: 42° C REAGENT FLOW RATE: 0.3 ML/MIN

CONDITIONS FOR METHANOLIC SAMPLES		
Time (Min)	Water %	MeOH %
0	85	15
0.5	85	15
28.5	30	70
28.6	0	100
33.5	0	100
33.6	85	15
41	85	15

Carbamate Test Mix, 2.5ppm, 10µl injection, 15 cm, Carbamate C₁₈ column(1846150)

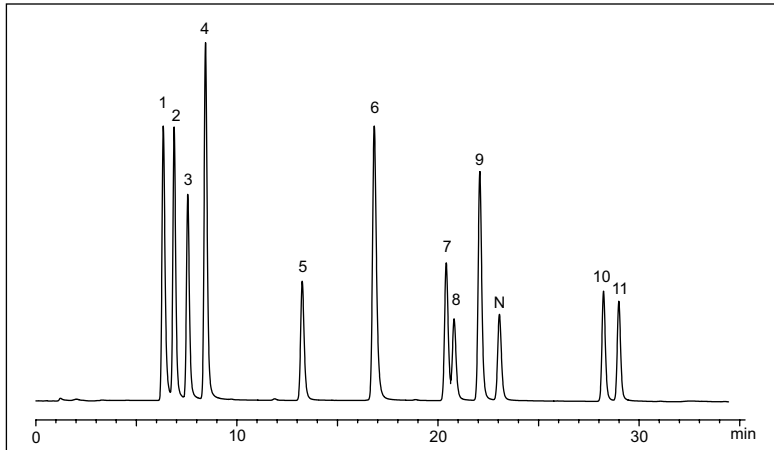

METHOD 4: 1846150 C₁₈ COLUMN (4.6X150 MM) WITH AQUEOUS SAMPLES**COLUMN TEMP: 42 °C****HPLC FLOW RATE: 1.0ML/MIN****REAGENT FLOW RATE: 0.3ML/MIN****CONDITIONS FOR AQUEOUS SAMPLES**

Time (Min)	Water %	MeOH %
0	100	0
1	100	0
1.1	88	12
26	30	70
26.1	0	100
28	0	100
28.1	100	0
38	100	0

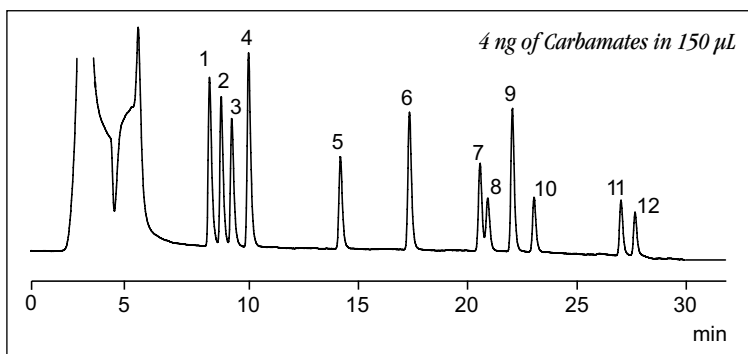

METHOD 5: 0846250 C₈ COLUMN (4.6X250MM) WITH METHANOLIC SAMPLES

HPLC FLOW RATE: 1.0ML/MIN

COLUMN TEMPERATURE: 42° C

REAGENT FLOW RATE: 0.3 ML/MIN

CONDITIONS FOR METHANOLIC SAMPLES		
Time (Min)	Water %	MeOH %
0	85	15
1	85	15
44	25	75
44.1	0	100
49	0	100
49.1	85	15
57	85	15

Carbamate Test Mix, 2.5ppm, 10µl injection, 25cm, Carbamate C₈ Column (0846250)

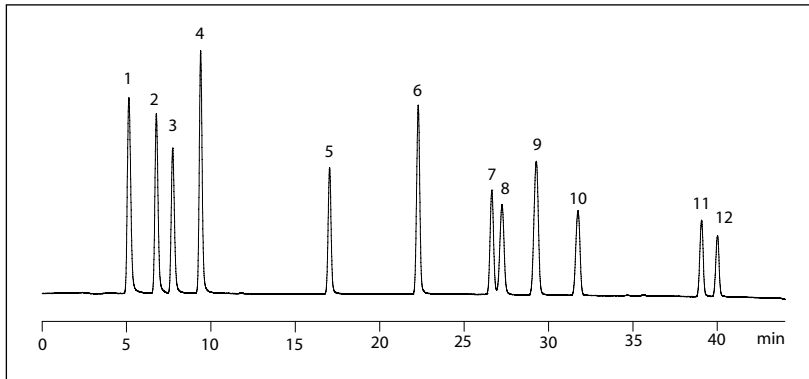

METHOD 6: 0846250 C₈ COLUMN (4.6X250MM) WITH AQUEOUS SAMPLES
HPLC FLOW RATE: 1.0ML/MIN COLUMN TEMPERATURE: 42° C

REAGENT FLOW RATE: 0.3 ML/MIN

CONDITIONS FOR AQUEOUS SAMPLES		
Time (Min)	Water %	MeOH %
0	100	0
1	100	0
1.1	82	18
36	30	70
39	30	70
39.1	0	100
41	0	100
41.1	100	0
55	100	0

Upon completion of the analysis, follow the shutdown procedure described in Section 4. Store the carbamate column in 100% Methanol

Note: The automatic valves prevent reagents from back-flowing onto the column. The inert gas should be left on to preserve the OPA reagent.

Precautions for Carbamate Analysis

Always wear gloves during the preparation of the reagents. The OPA and Thiofluor™ can cause skin irritation. The OPA reagent is sensitive to air oxidation, degrades over time, and should be prepared fresh for optimum sensitivity. OPA reagent maintains its activity for up to one week when pressurized with inert gas.

Thiofluor™ is extremely hygroscopic. Always keep in a tightly closed container.

The preparation of the OPA Diluent by the user is not recommended because sodium borate (any grades) contains excessive amounts of heavy metal contaminants and insoluble matter. These impurities will eventually precipitate in the reactor and flowcell. The one year warranty does not cover damage caused by these contaminants.

Use HPLC-grade methanol and water (Fisher Scientific, JT Baker, or Merck) for carbamate analysis to avoid problems with baseline drift, spurious peaks, and noise.

Use bottled HPLC-grade water if possible (Fisher Scientific, JT Baker, or Merck), especially during the initial system start-up. If water from a water purification system is used, ensure the system has an activated charcoal unit to eliminate organics, and that the charcoal cartridge is placed after the ion-exchange cartridges. (Many ion-exchange resins leach out OPA-positive contaminants that cause unacceptable fluorescence background.)

The water in the solvent reservoir should be changed every 3 to 4 days to prevent possible bacterial growth.

The test mixture for carbamate is for qualitative use only. It is not recommended for calibration purposes.

Filter all samples through a 0.45µm membrane filter. Some samples may require even more stringent filtration, especially if colloids are present.

Aqueous samples must always be properly buffered. Consult EPA Methods 531.1 or 531.2 for details.

For carbamate analysis with methanolic samples, inject – 10µl. Large amount of organic solvents can cause peak distortion.

For small aqueous sample volumes (< 150µl) either of the two Pickering columns can be used. For volumes greater than 300µl, use only the 25cm column. A gradient delay time should be programmed into the analysis (0% organic) to trap the sample onto the head of the column.

Avoid purging the system with 100% acetonitrile as precipitation of borate salt in the reactor might occur. Do not exceed 70% acetonitrile if it will be used as the mobile phase.

Do not store the column in water.

Use the Pickering Laboratories carbamate analysis column, which is specifically designed and tested for the separation of carbamates in the EPA Methods.

Notes

GLYPHOSATE

- 6.4** Introduction
- 6.4-1** Background
- 6.4-1** Basic Sample Preparation
- 6.4-2** Reagent Preparation
- 6.4-4** Analytical and Post-column Conditions
- 6.4-4** Analytical Procedure
- 6.4-5** Sample Chromatograms
- 6.4-6** Precautions
- 6.4-8** Notes

Introduction

High-performance liquid chromatography (HPLC) with post-column derivatization is a technique for rendering analytes more detectable than they would otherwise be in their native forms. Post-column derivatization can give improved sensitivity or better selectivity (reduction of interference) leading to lower detection limits.

The Pickering Laboratories Pinnacle PCX was developed to facilitate the determination of the herbicide glyphosate (and its metabolite AMPA), meeting or exceeding performance requirements of USEPA Method 547.

The Pickering Post-column method can also be used for the determination of Glyphosate and AMPA in plants and soils. Pickering has improved sample preparation procedure for vegetable samples. It is a simple extraction followed by clean-up on a strong cation-exchange cartridge. The procedure is listed later on in this chapter.

Background

Glyphosate and AMPA are separated on a strong cation-exchange column (fully sulfonated, cross-linked polystyrene, mixed K^+/H^+ form). After isocratic separation, the column is regenerated with dilute KOH, then re-equilibrated with eluant.

Fluorometric detection follows a two-stage post-column reaction. In the first stage, glyphosate is oxidized by hypochlorite to glycine. In the second stage, glycine reacts with *o*-phthalaldehyde and Thiofluor™ (a mercaptan) at pH 9–10 to produce a highly fluorescent isoindole. AMPA does not need the initial oxidation to react with OPA (Figure 6.4-A); indeed oxidation reduces its fluorescent yield.

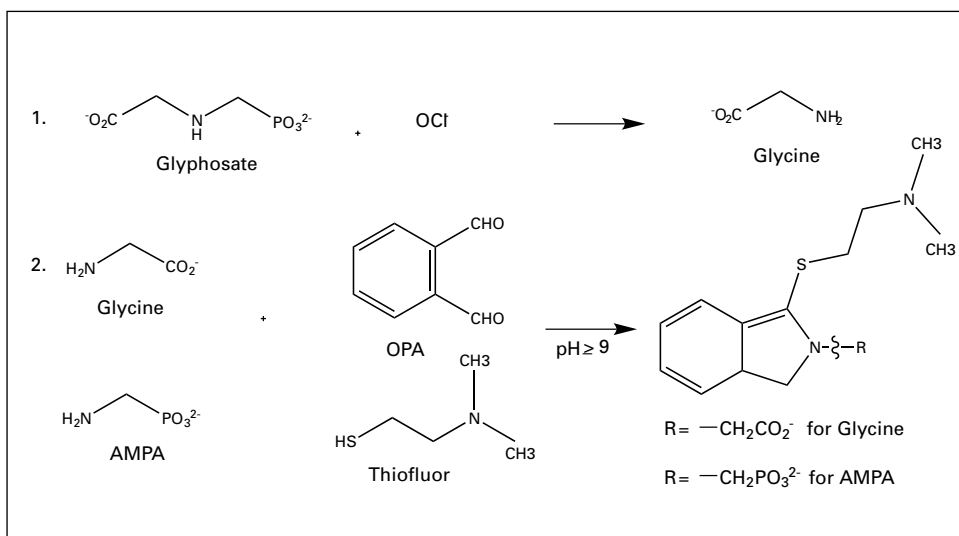

Figure 6.4-A

Basic Sample Preparation

The following is a suggested basic sample preparation for Vegetable and Water samples containing glyphosate. The method for Vegetables is different from the procedure called out by the AOAC. We have developed ion-exchange cartridges, which we have fully qualified in our lab, and which greatly improve the ease and reproducibility of the extraction while at the same time reducing many of the trouble aspects of the original published method (e.g. iron contamination).

FOR VEGETABLE SAMPLES

Extraction

To 25g of a homogenous sample add enough water (after estimation of moisture content) to make the total volume of water 125 ml. Blend at high speed for 3-5 min. and centrifuge for 10 min. Transfer 20 mL of the aqueous extract into a centrifuge tube and add 15 mL of methylene chloride (to remove nonpolar

co-extractives). Shake for 2-3 min. and centrifuge for 10 min. Transfer 4.5 mL of the aqueous layer into a vial and add 0.50 mL acidic modifier solution (16g KH_2PO_4 , 160 ml H_2O , 40 ml Methanol, 13.4 ml HCl). Shake and centrifuge for 10 min.

Matrix specific modification

Plants with high: 1) Water 2) Protein 3) Fat Content

- 1) For crops that absorb large amounts of water, reduce test portion to 12.5g keeping water volume the same.
- 2) For crops that have high protein content add 100 μl HCl to 20 ml aliquot of crude extract. Cap, shake and centrifuge for 10 min.
- 3) For crops that have high oil content, do the methylene chloride partition twice.

Cation-exchange cleanup

Transfer 1 mL of extract (representing 0.18g normal crop or 0.09g dry crop) to the column reservoir and elute to the top of the resin bed. Add 0.70 mL of the elution solution (160 mL H_2O , 2.7 mL HCl, 40 mL Methanol) and discard the effluent. Repeat with a second 0.70 mL portion and discard effluent. Elute with 12 mL of the elution solution and collect in a round-bottomed flask. Evaporate to dryness in a water bath set at 40°C using a rotary evaporator. Or collect in a centrifuge tube and evaporate using a vacuum vortex evaporator. Dissolve residue in 2.0 mL of the elution solution (use 1.5 ml for dry crops). Extracts before evaporation can be stored refrigerated for up to 7 days.

FOR WATER SAMPLES

Filter water through a $0.45\mu\text{m}$ membrane filter, and inject 200-400 μl .
If the glyphosate comes out as a doublet, add 2 drops of Restore directly to the sample vial.

Reagent Preparation

HYPOCHLORITE REAGENT

Note: 5% Sodium hypochlorite must be used for preparing oxidizing reagent (can be obtained from local grocery stores).

Pour 945 ml of the Hypochlorite Diluent (GA116) directly into the reagent reservoir. This should be labeled Oxidizing Reagent. Add 100 μl of 5% sodium hypochlorite solution to the diluent. The exact amount will depend on the actual hypochlorite concentration of the stock solution. When you get your first chromatograms, you will be able to adjust the amount to optimize the relative peak areas of glyphosate versus AMPA. Figure 6.4-B shows a typical response curve.

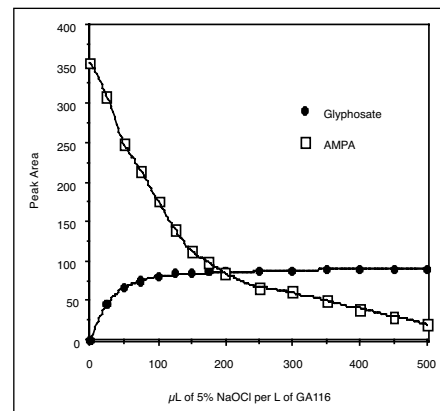

Figure 6.4-B

Cap the reservoir, close the vent valve, and swirl the solution to mix it thoroughly.

Note: The hypochlorite concentration slowly decreases with time. This will manifest itself as a change in the relative peak areas of glyphosate and AMPA. It will remain usable for several days, but we recommend you calibrate daily.

Caution! Do NOT use calcium hypochlorite in the oxidizing reagent. This will cause plugging of the post-column reactor. The one year warranty does not cover damage caused by calcium hypochlorite-based reagents. The EPA Draft Method 547 is wrong on this point; $\text{Ca}_3(\text{PO}_4)_2$ is insoluble in water.

OPA REAGENT

1. Pour 945 ml of the OPA Diluent (Cat. No. GA104) into the reagent reservoir. Save approximately 5 ml for step 5.
2. Put the cap on the bottle, open the vent valve, and turn on the gas supply. Thoroughly de-aerate the contents by sparging with inert gas. Continue bubbling for at least 10 minutes.
3. Dissolve 100 mg of OPA (Cat. No. O120) in approximately 10 ml of HPLC-grade methanol in a clean, dry container.
4. Turn off the gas supply and remove the cap from the bottle. Add the OPA solution to the deoxygenated Diluent in the reservoir.
5. Dissolve 2 g of Thiofluor™ (Cat. No. 3700-2000) in the reserved 5 ml of the OPA Diluent and add into the reservoir.
6. Replace the cap and turn on the gas flow. Continue sparging for another minute. Close the vent valve. Gently swirl the reagent to complete the mixing.

Caution! The preparation of the OPA Diluent by the user is not recommended because sodium borate (any grades) contains excessive amounts of heavy metal contaminants and insoluble matter. These impurities will eventually precipitate in the reactor and flowcell. The one-year warranty does not cover damage caused by these contaminants.

Note: The OPA reagent is sensitive to air oxidation and degrades over time. When the OPA reagent reservoir is maintained under inert gas pressure, the OPA reagent maintains its activity for up to one week without significant loss of activity.

Analytical and Post-column Conditions

These are the recommended conditions for glyphosate analysis using the 1954150 column and 1953020 guard column.

Column Temperature: 55°C
HPLC Flow Rate: 0.4 ml/min

HPLC Program:

Times (min)	%K200	%RG019	Comment
0	100	0	Inject
15.0	100	0	Isocratic
15.1	0	100	Regeneration
17	0	100	Isocratic
17.1	100	0	Step Change
27.0	100	0	Re-equilibration

The exact time of equilibration depends on the internal volume of your HPLC. When the baseline and column pressure are stable for two minutes, the column has been re-equilibrated.

Post-Column Conditions:

Reagent 1: 100 µl of 5% NaOCl in GA116 Diluent

Reagent 2: *o*-Phthalaldehyde and Thiofluor™ in GA104 Diluent

Pump 1 Flow Rate: 0.30 ml/min

Pump 2 Flow Rate: 0.30 ml/min

Reactor 1 Volume: 500 µl

Reactor 2 Volume: 100 µl

Reactor 1 Temp: 36°C

Reactor 2 Temp: Ambient

Analytical Procedure

Allow the column to equilibrate for about 20 minutes under initial conditions.

Inject 10µl of Glyphosate Text Mixture (or the appropriate volume of your standard), and collect the first chromatogram.

Figure 6.4-C shows a typical Glyphosate and AMPA chromatogram. In a standard with Glyphosate and AMPA at equal concentration, the peak heights should be equal. The peak heights are influenced by the amount of hypochlorite in Reagent 1.

Sample Chromatograms

Glyphosate Test Mix, 2.5ppm, 10 μ l injection

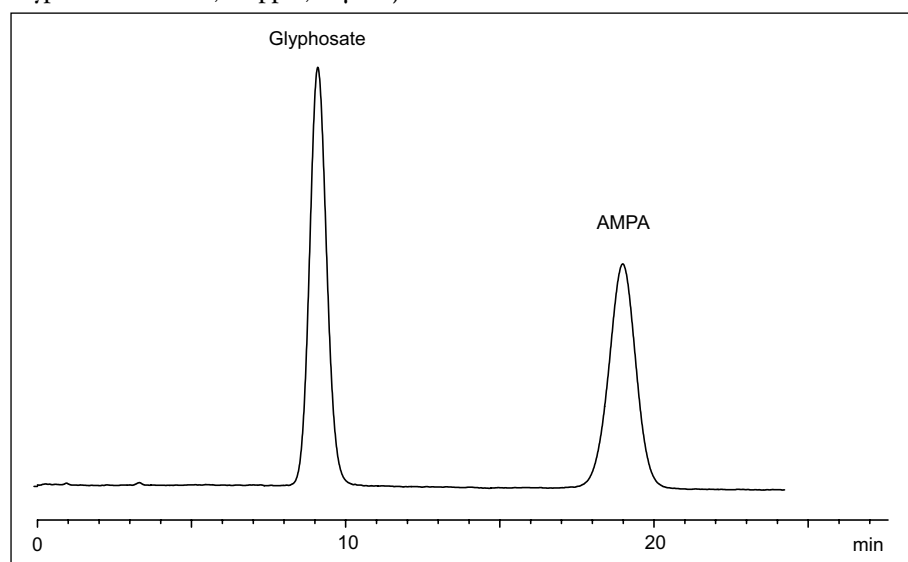

Figure 6.4-C

Glyphosate and AMPA, 13ppb in K200, 100 μ l injection

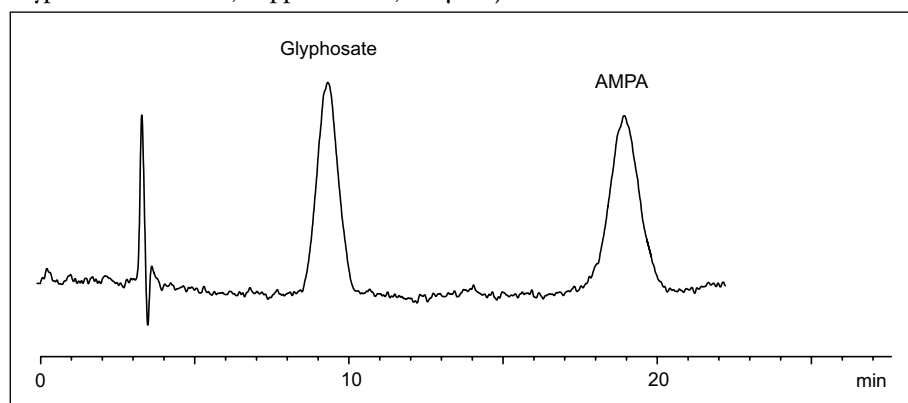

Figure 6.4-D

Broccoli sample spiked with Glyphosate and AMPA, 50 ppb, 100 µl injection

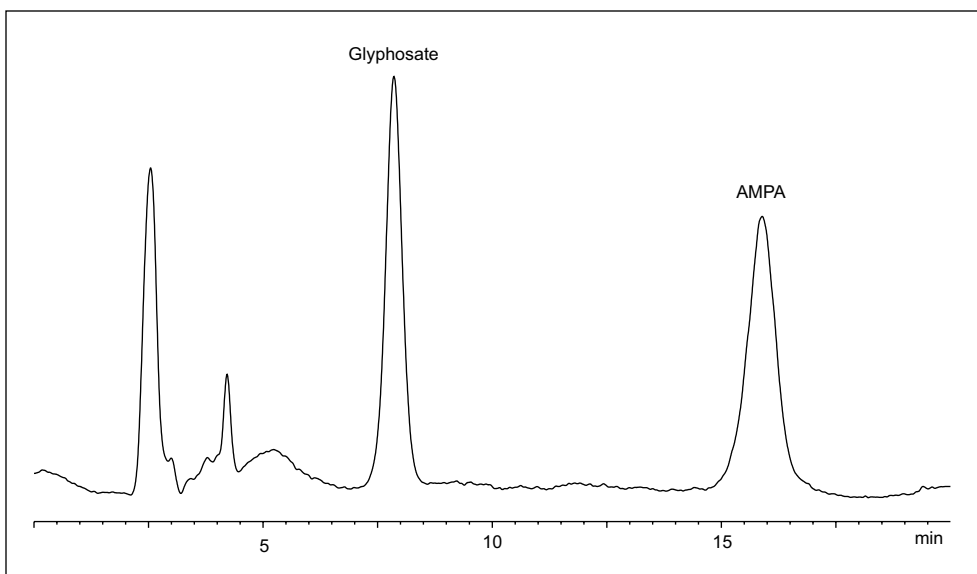

Figure 6.4-E

Upon completion of the analysis, follow the shutdown procedure described in Section 4. Store the column in RG019.

Excessive flushing will require an equally excessive re-equilibration when you start up again.

Note: The automatic valves prevent reagents from back-flowing onto the column. The inert gas should be left on to preserve the OPA reagent.

Precautions to be Aware of in Glyphosate Analysis

Always wear gloves during the preparation of the reagents. The OPA and Thiofluor™ can cause skin irritation. The OPA reagent is sensitive to air oxidation, degrades over time, and should be prepared fresh for optimum sensitivity. OPA reagent is stable for at least one week when pressurized with inert gas.

Thiofluor™ is extremely hygroscopic. Always keep in a tightly closed container.

The preparation of the OPA Diluent by the user is not recommended because sodium borate (any grades) contains excessive amounts of heavy metal contaminants and insoluble matter. These impurities will eventually precipitate in the reactor and flowcell. The one year warranty does not cover damage caused by these contaminants.

Use Restore™ if Iron contamination of the column is suspected.

Contamination usually occurs on the guard column. Wash it separately from the analytical column. This will save much time in the washing and re-equilibration.

Contaminants of special concern: iron and other polyvalent cations, organic dyes, surfactants, detergents, and lipids. They may cause irreversible damage.

Organic solvents will cause the resin in the column to swell. This leads to high back-pressure and broadened peaks. The column sometimes can be regenerated.

Use Pickering eluants with the Pickering column, as they are designed to work together.

The test mixture for glyphosate is for qualitative use only. It is not recommended for calibration purposes.

Filter all samples through a 0.45µm membrane filter. Some samples may require even more stringent filtration, especially if colloids are present.

Aqueous samples must always be properly buffered. Consult EPA Method 547 for details.

Notes

Notes

Section 7

TROUBLESHOOTING

- 7.1** Contact Pickering Laboratories for Support
- 7.2** Instrument Parameter Log
- 7.2** Troubleshooting Advice
- 7.3** Common System Problems
- 7.4** Common Chromatography Problems
- 7.6** Common Column Problems
- 7.7** Application-specific Troubleshooting
 - Amino Acids
 - Carbamates
 - Glyphosate
- 7.8** Software Troubleshooting
- 7.11** Procedures
 - To Remove Silica Deposits From Reactor
 - To Remove Mineral Deposits In The Reactor From Hard Water
 - To Remove Grease Deposits
 - If Reagent Backflows Onto Column
 - If Organic Solvent is On Cation-Exchange Column
 - If NaOH is On Column
 - To Remove Iron Contamination From Column
 - To Pump RESTORE Through The Glyphosate Column

CONTACT PICKERING LABORATORIES FOR SUPPORT

There are several easy ways to contact Pickering Laboratories for Technical Support:

Email: support@pickeringlabs.com
Telephone: 800-654-3330 or 650-694-6700
Fax: 650-968-0749
Web Site: www.pickeringlabs.com
Click on the Support tab to send us an email.

Pickering Laboratories' business hours are:
Monday thru Friday, 8 AM to 5 PM, Pacific Standard Time (GMT – 08:00)

We will ask you a set of standard questions:

What application are you running?

What are the pressures in your Pinnacle PCX system?

What is the brand and model of your HPLC system?

What type of samples are you injecting?

Please email or fax to us a chromatogram

Please email the Log files

INSTRUMENT PARAMETER LOG

If you should have any problems with your Pinnacle PCX, the Instrument Log file is a key resource to finding the cause of, and solving any problems. Pinnacle PCX records detailed information about the instrument parameters in the Log files. Pump(s) flow rates and pressures, reagent volume, column and reactor temperature, s and flags from HPLC are all stored for 4 days before being overwritten. Log files are necessary to troubleshoot Pinnacle PCX system and software and should always be collected after a problem is detected. To collect Log files go to **Help**, select **Send Log to Support** and select file from the day the problem happened. Save the file with the date stamp and e-mail it to support@pickeringlabs.com. If you are not sure about the time collect all 4 log files.

Pickering Laboratories strongly recommends that you record your daily operating pressures, and any maintenance performed on the instrument. This log will be invaluable to your laboratory for troubleshooting and problem prevention.

Make copies of the blank form in Appendix and complete the parameter log on the photocopy.

GENERAL TROUBLESHOOTING ADVICE

Rules of Dolan and Snyder [see references]

- Rule of One: Make one change at a time.
- Rule of Two: Confirm the problem before fixing it.
- Substitution Rule: Swap in a good part for a questionable one.
- Put it Back: If swapping does not fix it, put the original back in.
- Write it Down: Changes or modifications, incidents.
- Crystal Ball: Preventive maintenance saves more time in the long run.
- Buffer Rule: Remove buffers from LC when not in use.

General Procedure for Troubleshooting

- Examine the system front to back. Repair all leaks.
- Verify that all settings, eluants, reagents, valves, etc. are according to specifications.
- Have there been any changes in the system?
- Compare against reference conditions: standard sample, column, parameter log as appropriate.
- Gather information: observations, manuals, books, technical assistance.
- Test your conclusions about the nature of the problem.
- Start working.

Before making any change in the gradient, temperature, or other operating conditions, get at least two chromatograms in a row with the same problem. After you make a change, get at least two chromatograms showing the same effect of the change. This is especially true when you are trying to optimize gradient conditions.

COMMON SYSTEM PROBLEMS

OBSERVED PROBLEM	COMMON CAUSE	ACTION TO TAKE	NOTES
Low Reagent pressure	Air in reagent pump Reagent flow rate too low Leaking fittings	Check for leaks Change pump seals	Perform Flush Pump Tighten leaking fittings
High Reagent pressure	Obstruction of flow path by deposits Over-tightened fittings Pinched tubing Obstruction of detector flow-cell Defective back-pressure regulator	Determine the exact location of the blockage. Disconnect one fitting at a time, moving backward from the back-pressure regulator end, until the pressure drops	For partial blockage, clean tubing with solvent/water For total blockage, replace appropriate part
Reagent pump stops or delivers wrong flow rate		Check pump setting Check reagent pressurization Check pump seal for leakage Test or clean valves	

continued

COMMON SYSTEM PROBLEMS *continued*

OBSERVED PROBLEM	COMMON CAUSE	ACTION TO TAKE	NOTES
Over-pressure relief valve is opened	There is a blockage in the system	Determine the exact location of the blockage. Disconnect one fitting at a time, moving backward from the back-pressure regulator end, until the pressure drops	Flush the system with solvent/water until pressure drops, or replace appropriate part
Blocked Heated Reactor reactor	Improper Shutdown Dissolved silica precipitating in the reactor Contaminated reagents Mineral deposits from hard-water samples or reagents Greasy samples Use of calcium hypochlorite Home-made reagents Hydrindantin deposits from Expired TRIONE	Follow the procedure for removing mineral deposits on Page 7.8 Follow the procedure for removing Silica deposits on Page 7.8 Replace heated reactor if flushing does not help	Silica from NaOH backflow onto column Use of calcium hypochlorite as the oxidant in glyphosate determination Preparing your own reagents with poor quality chemicals

COMMON CHROMATOGRAPHY PROBLEMS

When having chromatography problems collect 2-3 chromatograms that show the problem. Fax these and most recent normal one to Pickering Laboratories at (650) 968-0749.

OBSERVED PROBLEM	COMMON CAUSE	ACTION TO TAKE	NOTES
High Background Signal	Contaminated Eluant Bacterial Growth Fingerprints Contaminated Reagent(s) Defective chemicals	Flush HPLC system and Pinnacle PCX with 80/20 Water/MeOH Put new eluants on HPLC, make new reagents	
Noisy Baseline	Worn pump seal Detector noise Chemical contamination Reagent too old	Check for pattern in the noise. If the background signal is also elevated, check for chemical contamination, or an error in formulation	Match the frequency of the noise to one of the pumps. If the noise is random, check the detector

continued

COMMON CHROMATOGRAPHY PROBLEMS *continued*

OBSERVED PROBLEM	COMMON CAUSE	ACTION TO TAKE	NOTES
Peaks disappear or diminish	Improper Reagent preparation Out of Reagent Reactor at wrong temperature Reagent flow rate improper Dirty flowcell Dirty autosampler Deteriorated samples Metal contamination of column due to poor sample preparation or corrosion in system Oxidized TRIONE or OPA Reagent pump mis-adjusted Iron contamination of column.	Prepare fresh reagents Prepare fresh standards from neat reference material. Test with a second fluorescent or UV/VIS detector. Change the rotor seal of the autosampler or use a manual injector. Flush amino acid column with regenerant. Check reactor temperature Clean the flowcell Follow the procedure for Iron removal from the column on Page 7.9 Remove all stainless steel frits from reservoirs Clean or replace any corroded parts. Flush Glyphosate column with Restore	All disappear except 1-naphthol and carbaryl = OPA reagent expired All disappear except 1-naphthol = Out of Hydrolysis Reagent Varied peak size, some missing = Reactor at wrong temperature All peaks diminish = dirty flowcell, autosampler, or deteriorated samples Solution standards, even stored in ampoules, are not reliable (esp. when dissolved in ACN) A UV-Vis detector set at 330nm may be used Iron contamination caused from samples, long column storage, stainless steel frits in the eluant reservoirs, corrosion in system
Retention times not stable, especially in early part of chromatogram	Re-equilibration time is too short. Too much internal volume in HPLC pump or pulse dampener. Leaking proportioning valve in HPLC Autosampler Problems	Increase it by two minute increments. Re-plumb system as described in the installation section for amino acids.	
Artifacts in Baseline	Contamination in Eluant reservoir Corrosion of spargers or filters Volatile amines used in laboratory	Replace eluants Clean reservoir with soap and water Remove spargers or eluant filters Remove any reagents used in amine synthesis, or cigarette smoke laden clothing	
Retention times drift over a long time	Buildup of contaminants Room temperature changes greatly with the seasons	Flush the column Air condition the room	

COMMON COLUMN PROBLEMS

OBSERVED PROBLEM	COMMON CAUSE	ACTION TO TAKE	NOTES
Loss of Resolution	Guard column dirty Bad tubing connection: wrong style nut, too large tubing, wrong type union Column worn out		
Poor Peak Shape - General	Column worn out Guard column dirty Deposits in post-column flow path Partial obstruction of flowcell Too strong a solvent Too large a sample injected Reagent flow rate too high. Improper tubing connection. Protein contamination on amino acid column	Start by replacing filter, then guard. Replace column as last resort. If new tubing connections have been made, check connections. Ensure that protein is completely removed from column	Send a chromatogram to Pickering Laboratories' Technical Support Department Improper tubing connections are: wrong style nut, too large tubing, wrong type union, improper swaging of ferrule. Reverse and flush ion-exchange column at elevated temperature
Reagent backflows into column	Improper Shutdown procedures Improper maintenance Procedures Leaking fittings between column and HPLC pump Defective reagent control valves.	If NaOH is on column, follow procedure on Page 7.9 If Reagent backflows onto column, follow the procedure on Page 7.8	
High Column pressure	Guard column is blocked. Worn HPLC seal or rotor seal. Particulate matter in eluant reservoirs Column is damaged Organic solvent in ion exchange column NaOH on Carbamate column Excessive eluant flow rate through column	For reagent back-flow onto column, see above. If the column back-pressure is high (> 2800psi), isolate the source of the high pressure and replace appropriate part. The analytical column can be back-flushed to clear partial blockage. Disconnect the outlet of the column during the back flush operation. If organic solvent is on the cation-exchange column, follow the procedure on Page 7.8	Unfiltered samples Pressure from filter and guard should be < 200psi). Organic contaminants can be washed off the carbamate column by first washing with methanol then with dichloromethane. Wash again with methanol before use

APPLICATION SPECIFIC TROUBLESHOOTING

OBSERVED PROBLEM	COMMON CAUSE	ACTION TO TAKE	NOTES
AMINO ACID			
Peak areas diminish	Old heated reactor	Replace heated reactor	Replace heated reactor every 2 years
Poor Aspartic Acid Shape	Wrong pH or buffer for sample		
Threonine/Serine Resolution decreases	Dirty guard Worn Column	Reverse guard column and flush with 100% regenerant Repack or replace guard/analytical column	
Hydrindantin Deposits in Reactor	Caused by out-of-date Trione	Clean entire system with ethanaol. Replace reagent filter.	
CARBAMATES			
Grease deposits in the heated reactor	Fatty samples used in carbamate analysis.	Follow the procedure on Page 7.11	
GLYPHOSATE			
Glyphosate peak is a doublet	Improperly buffered samples	Add 1-2 drops of Glyphosate RESTORE to the sample	RESTORE Cat. No. 1700-0140
Glyphosate and AMPA peaks are late and broad	Iron contamination of Column Extremely large ID injection loop	Follow the procedure for pumping RESTORE through the column	Replace the large ID loop with a smaller ID.
Glyphosate peak too small or gone, but AMPA present	Oxidizing reagent too weak, too old, NaOCl stock solution too old Reactor at wrong temperature		
AMPA peak disappears, but Glyphosate present	Oxidizing reagent too strong	Make fresh Oxidizing reagent	

Software Troubleshooting

The software will alert you about common mistakes with Method and Sequence settings as well as with starting up the Instrument. Read all the messages carefully.

Always collect the Log Files after problem is observed by going to **Help – Send log to support**. It is essential that log file be collected from the day the problem occurred. If you are not sure when exactly the problem happened collect all 3 available logs.

Helpful tip: check the size of the log file after you save it. File that is less than 100 KB is likely to be empty or corrupted. Delete it and collect the log again.

OBSERVED PROBLEM	COMMON CAUSE	ACTION TO TAKE	NOTES
"Not Connected" is displayed in the status bar	Configuration is incorrect	Check that the correct connection method is set in Configuration.	Contact your System Administrator for IP address if needed.
Pinnacle refills full syringe instead of just enough reagent for 1 run	Method not loaded	Create and load a Sequence with correct post-column Method	
After loading a new Sequence last method from the old one is still displayed	New settings did not get accepted	Restart the Pinnacle PCX software	
Pinnacle does not refill after the first run is completed	Pump was turned ON but Sequence was not started Injection signal was not received	Make sure Start is selected from the Sequence menu See below	After first run is started check that Run time displayed in the Status bar matches elapsed run time of the HPLC.
"No relay signal" is displayed	Injection signal was not received and Sequence was stopped	Check that correct brand of HPLC is set in Configuration Make sure that Equilibration time and Run time of Pinnacle Method match run and equilibration time of the HPLC method (see section 4 of this Manual) Minimum Equilibration time for Pinnacle PCX is 5 min	Check relay connections on the back of your HPLC system and Pinnacle PCX. Set the change of relay state in your HPLC method close to time 0.0. If equilibration time is set as part of the gradient table consider how long the actual analysis and equilibration steps are. Match analysis time to Run time of the Pinnacle PCX and match time of the equilibration step to Equilibration time of the Pinnacle PCX.

continued

SOFTWARE TROUBLESHOOTING *continued*

OBSERVED PROBLEM	COMMON CAUSE	ACTION TO TAKE	NOTES
Pinnacle PCX misses command during Sequence run (stops in the middle of the Sequence, fails to refill, fails to pump reagent, etc)	Slow communication between PC and Pinnacle PCX	Collect the log file and contact Pickering Laboratories to confirm the cause of the problem. If using USB cable change to Ethernet.	Make sure no updates are scheduled on your computer when analysis is running
"Sequence done" is displayed in Pinnacle PCX software but not all your samples were completed	Number of runs in Pinnacle PCX Sequence and HPLC sequence do not match Pinnacle PCX sequence was modified during the run but changes were not saved	More runs set up in HPLC sequence than in Pinnacle PCX. Make sure you match total number of runs in the HPLC sequence. When modifying currently running sequence press Save and then Load	HPLC software usually displays only number of unknown samples and do not count number of calibrators or control. Check number of runs displayed in the status bar to confirm that changes were accepted
HIGH PRESSURE on Pump 1(2)	Pump pressure exceeded 500 psi	Completely or partially blocked: <ul style="list-style-type: none"> • reagent filters • heated or ambient reactors • detector flow cell • connecting tubings • backpressure regulator 	See troubleshooting table for details on dealing with blockages
Transducer 1(2) not connected	Transducer connection to the main board is loose Transducer or main board are defective	Open the Pinnacle PCX right side panel and check that transducer is connected Install a new transducer or a main board	Contact Pickering Laboratories before changing any major components Unplug Pinnacle PCX before checking electrical connections
Column temp sensor error	Column temperature sensor is not connected to the main board Column temperature sensor or main board are defective	Open the Pinnacle PCX left side panel and check that column temperature sensor is connected Install a new column temperature sensor or a main board	Contact Pickering Laboratories before changing any major components Unplug Pinnacle PCX before checking electrical connections

continued

SOFTWARE TROUBLESHOOTING *continued*

Reactor temp sensor error	Heated reactor is not connected to the main board Heated reactor or main board are defective	Open the Pinnacle PCX right side panel and check that heated reactor is connected Install a new heated reactor or a main board	Contact Pickering Laboratories before changing any major components Unplug Pinnacle PCX before checking electrical connections
Column temp at MAX	Column heater, column temperature sensor or main board are defective	Send Pinnacle PCX to Pickering Laboratories for repairs	Pinnacle PCX over temperature switches are single use only. They need to be replaced at the factory before Instrument can be used again
Reactor temp at MAX	Reactor heater, reactor temperature sensor or main board are defective	Send Pinnacle PCX to Pickering Laboratories for repairs	Pinnacle PCX over temperature switches are single use only. They need to be replaced at the factory before Instrument can be used again
Valve 1(2) lost	Valve can not find specified position	Valve is misaligned Valve's o-rings need replacement Main board or valve motor and sensors are defective	Buy valve resealing kit and change o-rings. Align valve as described on page 5-9 Replace main board or valve motor Contact Pickering Laboratories before changing any major components Unplug Pinnacle PCX before checking electrical connections

PROCEDURES

TO REMOVE SILICA DEPOSITS FROM REACTOR

Silica deposits are too hard to remove. Replace the reactor(s). Carefully clean or replace other components in the flow path. You must remove all the silica before the system will work again. This will probably entail major repair.

TO REMOVE MINERAL DEPOSITS IN THE REACTOR FROM HARD WATER

The Pickering pumps and most (but not all) HPLC pumps will tolerate this. Columns and autosamplers probably will not tolerate this.

1. Remove analytical column
2. Start HPLC pump at < 0.5 mL/min (100% H₂O).
3. Replace both post-column reagents with deionized water. Run post-column pumps for 5–10 min.
4. Stop post-column pumps. Replace deionized water with 20% nitric acid and run post-column pumps for 10–15 min.
5. Reverse the order of washing with water and then replace with the post-column reagents.

TO REMOVE GREASE DEPOSITS

Grease deposits can be dissolved by replacing column and guard with a union and pumping methanol through the HPLC and post-column systems. Stronger solvents such as acetone, methylene chloride, or tetrahydrofuran (THF) may be needed. If methylene chloride is used, be certain to flush the system thoroughly with methanol before and after because methylene chloride is not miscible with water.

IF REAGENT BACKFLOWS ONTO COLUMN

This procedure usually works but may not work every time.

1. Shut down the Pinnacle PCX.
2. Flush both columns with regenerant. Use a very slow flow rate so that the back pressure does not exceed 2000 psi. Collect effluent in a beaker.
3. Keep flushing until the pressure drops. Keep raising the flow rate until the pressure is normal at 0.40 mL/min and 55C.
4. Run a chromatogram to check for resolution.

IF ORGANIC SOLVENT IS ON CATION-EXCHANGE COLUMN

Even small amounts of common organic solvents like Methanol or Acetonitrile will cause cation-exchange resin to swell leading to high column pressure. Always make sure all organic solvent are removed from HPLC system and all the connecting lines before installing cation-exchange column. Small amounts of organic solvents from HPLC system could be removed by the procedure below. Guard column and analytical column should be flushed separately.

1. Remove the column and flush HPLC system with water. Put column Regenerant on.
2. Connect the column in reversed direction and flush with Regenerant. Use a very slow flow rate so that the back pressure does not exceed 2000 psi.
3. Keep flushing until pressure drops. Keep raising the flow rate until pressure is normal at standard operating conditions. Normal pressure for guard column is < 500 psi. Normal column pressure without a guard <2000 psi.
4. Reinstall guard and analytical columns in normal direction.
5. Run a chromatogram to check for resolution.

IF NaOH IS ON COLUMN

- 1) Do not restart the system. Dissolved silica or C18 phase will reprecipitate in the post-column reactors, or flowcell. These additional complications then require replacement of both reactor coils as well as your column.
- 2) Immediately depressurize the post-column system by loosening the “To Detector” fitting.
- 3) Disconnect the outlet of the column.
- 4) Restart the HPLC pump to flush the column with 100% MeOH for 20 minutes. Complete steps 2–4 as quickly as possible because the longer the hydroxide stays inside the column, the less chance that the column will survive.
- 5) Catch the effluent from the column with paper towels. Alternatively, connect the outlet of the column to a piece of spare tubing directing the effluent to waste.
- 6) Turn off the HPLC pump and reconnect the outlet of the column and the “To Detector” fitting.
- 7) Turn on the HPLC and post-column system and run a calibration standard. Pay special attention to the first four peaks. If these four peaks are not resolved, the column needs to be replaced.

TO REMOVE IRON CONTAMINATION FROM COLUMN

Flush guard and column with the Glyphosate Restore solution.

TO PUMP RESTORE THROUGH THE GLYPHOSATE COLUMNS

Usually only the guard column is contaminated. We suggest you buy a spare guard column to minimize down-time.

- 1) Remove the analytical column after ensuring no residual post-column pressure.
- 2) Reverse the guard column and pump RESTORE through the guard at 0.4 mL/min for a minimum of 30 min, directing the effluent to waste.
- 3) Pump K200 eluant through the guard long enough to displace RESTORE — about 30 min
- 4) Reconnect the column and guard in the normal directions and restart the HPLC and post-column systems. If analytical column is also contaminated, reverse the column and flush with Restore for 2 hrs. Equilibrate with K200 for 1 hour before use.

APPENDICES

- 8.2** Installation/Operational Qualitication of the Pinnacle PCX
- 8.7** Installation/Operational Qualitication of the Pinnacle PCX Data Sheet
- 8.8** Performance Qualifications of the Pinnacle PCX Data Sheet
- 8.15** Sample Instrument Parameter Log
- 8.16** Flow Diagrams
 - Simplex
 - Duplex
- 8.18** Consumables and Spare Parts
 - Amino Acid Analysis
 - Carbamate Analysis
 - Glyphosate Analysis
- 8.24** Limited Warranty
- 8.25** References

Installation/Operational Qualification of the Pinnacle PCX

Installation Qualification Completed By: _____ Date: _____

Operational Qualification Completed By: _____ Date: _____

1.0 PURPOSE:

To qualify the installation and operation of the Pinnacle PCX

2.0 REFERENCES:

- 2.1 Operators Manual for the Pinnacle PCX
- 2.2 Installation / Operational Qualification of the Pinnacle PCX Data Sheet. Section 8.3 of the Operators Manual for the Pinnacle PCX.

3.0 EQUIPMENT:

	Date	Initials
3.1 Installation / Operation Qualification		
Coordinator: _____	_____	_____
3.2 Equipment:		
Asset #: _____		
Serial #: _____		
Location: _____	_____	_____

4.0 GENERAL INSTALLATION QUALIFICATIONS:

	Date	Initials
4.1 Pinnacle Site Requirements:		
Space: <u>21.50 H x 10.63 W x 18.25 D inches (54.0 x 26.7 x 46.4 cm)</u>		
Electrical: <u>120 or 240 V</u>		
Weight: <u>26 lbs (11.6 kg) for Dual-pump systems</u>		
Gas: <u>Nitrogen or Helium</u>		

4.2 Pinnacle Installation Qualification:

- 4.2.1 Follow Section 3 in the Operators Manual for the Pinnacle PCX for installation details of the Pinnacle PCX.
- 4.2.2 Complete the Installation Qualification Check List in the Installation Operation / Qualification of the Pinnacle PCX Data Sheet, Section 8.7 of the Operators Manual for the Pinnacle PCX.

5.0 OPERATION QUALIFICATION:

5.1 Pump Flow Rate Accuracy

- 5.1.1 Turn on the Pinnacle PCX.
- 5.1.2 Fill the reagent bottle with Water and tightly close the cap.
- 5.1.3 Make sure the reagent caps are not vented to the atmosphere and that the lines to the pump are open (parallel), and turn the gas toggle valve to "ON".

- 5.1.4 Connect the outlet of Valve Port 2 directly to your flow meter. Use Valve 1 when testing Pump 1 and use Valve 2 when testing Pump 2.
- 5.1.5 Disconnect the analytical column to the Pinnacle PCX. This is the blue PEEK tubing that goes into the first mixing tee. Replace the blue peek tubing with a plug into the mixing tee. This will prevent any leaking out of the mixing tee. At this point the analytical column is completely disconnected from the Pinnacle PCX.
- 5.1.6 Open the Pinnacle Control Software and configure the instrument to have no connection to the HPLC. This will allow you to operate the Pinnacle without experiencing a time-out error due to no injection signal from the HPLC.
- 5.1.7 Create a method with the following parameters:

The image shows a screenshot of the 'Advanced Settings' tab in the Pinnacle Control Software. The settings are as follows:

Parameter	Value
Runtime, min	60
Equilibration time, min	5
Column t, °C	30
Column Type	NA
Reactor t, °C	30
Reactor Volume, ml	NA
Pump1 Flow Rate, ml/min	1.0
Reagent 1	Water
Pump2 Flow Rate, ml/min	0
Reagent 2	Water

- 5.1.8 Create a sequence to run the method in Step 5.1.7 once.

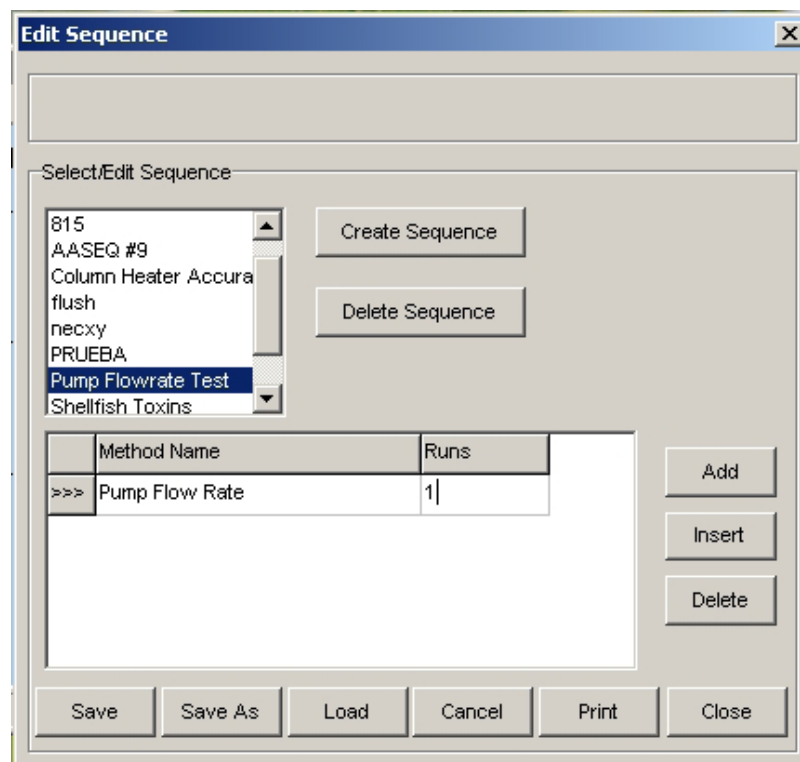

- 5.1.9 Save, and then load this sequence. Enable the instrument by selecting Enable under the Control menu. Once the Pinnacle is enabled, refill the pumps by selecting Refill Pumps under the Control menu.
- 5.1.10 Now start the sequence by selecting Start Sequence under the Sequence menu.
- 5.1.11 Allow a few minutes for the pump pressure to stabilize before recording a flow-rate reading. The specifications for flow-rate accuracy are on the Installation / Operational Qualification of the Pinnacle PCX Data Sheet, Section 8.8 of the Operators Manual for the Pinnacle PCX.
- 5.1.12 Repeat steps 5.1.7 through 5.1.11 for Pump 2. Make sure to program the flowrate of Pump 2 to 1.0ml/min and change the flowrate of Pump 1 to 0ml/min. If you have a single pump system, proceed to the next step.

5.2 Column Heater Accuracy

- 5.2.1 Place a temperature probe or thermocouple inside of the column heater. Make sure the probe or thermocouple is not touching the metal sides or the column door. The probe or thermocouple must be measuring the temperature of the air inside the column heater.
- 5.2.2 Close the column heater door.

5.2.3 Create a method with the following parameters:

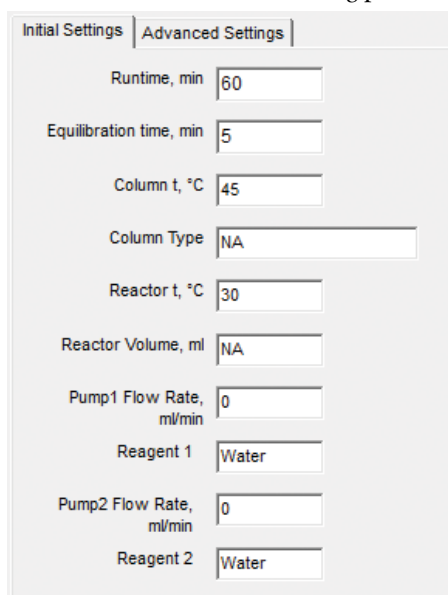

Initial Settings | Advanced Settings

Runtime, min 60

Equilibration time, min 5

Column t, °C 45

Column Type NA

Reactor t, °C 30

Reactor Volume, ml NA

Pump1 Flow Rate, ml/min 0

Reagent 1 Water

Pump2 Flow Rate, ml/min 0

Reagent 2 Water

5.2.4 Create a sequence with one run of the method created in Step 5.2.3

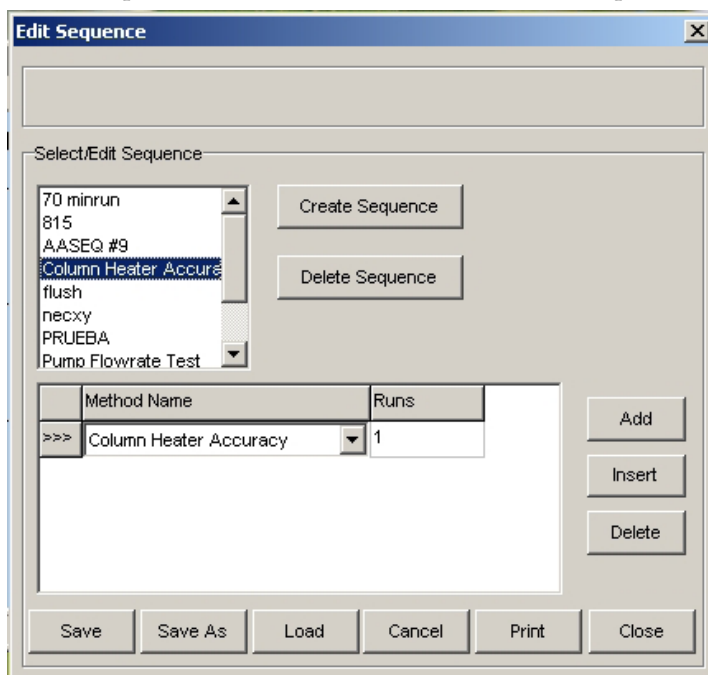

Edit Sequence

Select/Edit Sequence

70 minrun
815
AASEQ #9
Column Heater Accuracy
flush
necxy
PRUEBA
Pump Flowrate Test

Create Sequence

Delete Sequence

Method Name	Runs
>>> Column Heater Accuracy	1

Add

Insert

Delete

Save Save As Load Cancel Print Close

5.2.5 Save and then Load the sequence that was created in Step 5.2.4.

Installation/Operational Qualification of the Pinnacle PCX Data Sheet

Serial Number:

Customer:

120V or 240V

Asset:

Installation Qualification Check List

Are all of the contents listed on the packing list present?	Yes / No
Is there enough bench space between the HPLC and detector so the Pinnacle Column Heater Door and Pinnacle Cover can open without obstruction?	Yes / No
Is there at least 3 inches behind the Pinnacle PCX for ventilation?	Yes / No
Is there any damage on the outside of the Pinnacle PCX?	Yes / No
Is there any damage inside the Pinnacle PCX?	Yes / No
Are all electrical connections secure?	Yes / No
Is the gas source regulator set to a maximum of 75 psi?	Yes / No
Is a waste bottle provided by the user?	Yes / No
Is the HPLC correctly deadheaded? Refer to Section 3.9 or the Operators Manual for the Pinnacle PCX.	Yes / No
Does the display turn on when the Pinnacle PCX is powered on?	Yes / No
Do the valves find home position when the Pinnacle PCX is turned on? The home position is when the "V" on the valve is between 2 and 3.	Yes / No
Does the gas toggle valve turn the gas on and off?	Yes / No

APPENDICES

Serial Number:

120V or 240V

Customer:

Asset:

Performance Qualifications of the Pinnacle PCX Data Sheet**Flow Rate Accuracy****Pump 1**

Flowrate Setpoint in mL/min	Record Flowrate in ml/min	Specifications	Pass / Fail
1.0		+/- 0.030 ml/min	

Pump 2

Flowrate Setpoint in mL/min	Record Flowrate in ml/min	Specifications	Pass / Fail
1.0		+/- 0.030 ml/min	

Column Heater Accuracy

Column Temperature Setpoint in deg C	Recorded Temperature in deg C	Specification	Pass / Fail
45.0		+/- 1 deg C	

Comments: _____

Performed By: _____

Date Performed: _____

Reviewed By: _____

Date Reviewed: _____

Next Due Date: _____

Serial Number: Customer:
 120V or 240V Asset:

Glyphosate Application

Glyphosate Column Part Number: Serial Number:

Glyphosate Guard column Part Number:

Glyphosate Test Mixture (p/n 1700-0080) Lot Number:

Thiofluor (p/n 3700-2000) Lot Number:

o-phthalaldehyde (p/n O120) Lot Number:

Glyphosate OPA Diluent (p/n GA104) Lot Number: Expiration Date:

Glyphosate Hypochlorite Diluent (p/n GA116) Lot Number: Expiration Date:

Glyphosate Potassium Eluant (p/n K200) Lot Number: Expiration Date:

Glyphosate Column Regenerant (p/n RG019) Lot Number: Expiration Date:

Glyphosate	Retention Time in min	Average Retention Time	Standard Deviation	% CV	Specification	Pass / Fail
Run 1					≤ 0.5%	
Run 2						
Run 3						
Run 4						
Run 5						
Run 6						

Glyphosate	Peak Area	Average Peak Area	Standard Deviation	% CV	Specification	Pass / Fail
Run 1					≤ 1.5%	
Run 2						
Run 3						
Run 4						
Run 5						
Run 6						

APPENDICES

Carbamate Application

Carbamate Column Part Number:

Serial Number:

Carbamate Guard column Part Number:

Carbamate Test Mixture (p/n 1700-0063)

Lot Number:

Thiofluor (p/n 3700-2000)

Lot Number:

o-phthalaldehyde (p/n O120)

Lot Number:

Carbamate OPA Diluent (p/n CB910)

Lot Number:

Expiration Date:

Carbamate Hydrolysis Reagent (p/n CB130 or CB130.2) Lot Number:

Expiration Date:

Aldicarb sulfoxide	Retention Time in min	Average Retention Time	Standard Deviation	% CV	Specification	Pass / Fail
Run 1					≤ 0.5%	
Run 2						
Run 3						
Run 4						
Run 5						
Run 6						

Aldicarb	Retention Time in min	Average Retention Time	Standard Deviation	% CV	Specification	Pass / Fail
Run 1					≤ 0.5%	
Run 2						
Run 3						
Run 4						
Run 5						
Run 6						

Aldicarb sulfoxide	Peak Area	Average Peak Area	Standard Deviation	% CV	Specification	Pass / Fail
Run 1					≤ 1.5%	
Run 2						
Run 3						
Run 4						
Run 5						
Run 6						

Aldicarb	Peak Area	Average Peak Area	Standard Deviation	% CV	Specification	Pass / Fail
Run 1					≤ 1.5%	
Run 2						
Run 3						
Run 4						
Run 5						
Run 6						

Sodium Amino Acids Application

Amino Acid Column Part Number:

Serial Number:

Guard column Part Number:

Test Mixture (p/n 1700-0070)

Lot Number:

Trione (T100 or T200):

Lot Number:

Na Eluant Buffer A:

Lot Number:

Expiration Date:

Na Column Reagent (p/n RG011)

Lot Number:

Expiration Date:

Threonine	Retention Time in min	Average Retention Time	Standard Deviation	% CV	Specification	Pass / Fail
Run 1					≤ 0.5%	
Run 2						
Run 3						
Run 4						
Run 5						
Run 6						

Serine	Retention Time in min	Average Retention Time	Standard Deviation	% CV	Specification	Pass / Fail
Run 1					≤ 0.5%	
Run 2						
Run 3						
Run 4						
Run 5						
Run 6						

Cysteic Acid	Retention Time in min	Average Retention Time	Standard Deviation	% CV	Specification	Pass / Fail
Run 1					≤ 0.5%	
Run 2						
Run 3						
Run 4						
Run 5						
Run 6						

APPENDICES

Threonine	Peak Area	Average Peak Area	Standard Deviation	% CV	Specification	Pass / Fail
Run 1					≤ 1.5%	
Run 2						
Run 3						
Run 4						
Run 5						
Run 6						

Serine	Peak Area	Average Peak Area	Standard Deviation	% CV	Specification	Pass / Fail
Run 1					≤ 1.5%	
Run 2						
Run 3						
Run 4						
Run 5						
Run 6						

Cysteic Acid	Peak Area	Average Peak Area	Standard Deviation	% CV	Specification	Pass / Fail
Run 1					≤ 1.5%	
Run 2						
Run 3						
Run 4						
Run 5						
Run 6						

HPLC Method Table

Time	Buffer A*	RG011
0	100	0
20	100	0
20.1	0	100
24	0	100
24.1	100	0
Stop Time 24 min		
Post Time 12 min		

* Use the A Buffer corresponding to the column you have. The column insert will have the correct initial buffer listed in the method.

Lithium Amino Acids Application

Amino Acid Column Part Number:

Serial Number:

Guard column Part Number:

Test Mixture (p/n 1700-0070)

Lot Number:

Trione (T100 or T200):

Lot Number:

Li Eluant Buffer A:

Lot Number:

Expiration Date:

Li Column Reagent (p/n RG003)

Lot Number:

Expiration Date:

Threonine	Retention Time in min	Average Retention Time	Standard Deviation	% CV	Specification	Pass / Fail
Run 1					≤ 0.5%	
Run 2						
Run 3						
Run 4						
Run 5						
Run 6						

Serine	Retention Time in min	Average Retention Time	Standard Deviation	% CV	Specification	Pass / Fail
Run 1					≤ 0.5%	
Run 2						
Run 3						
Run 4						
Run 5						
Run 6						

Cysteic Acid	Retention Time in min	Average Retention Time	Standard Deviation	% CV	Specification	Pass / Fail
Run 1					≤ 0.5%	
Run 2						
Run 3						
Run 4						
Run 5						
Run 6						

APPENDICES

Threonine	Peak Area	Average Peak Area	Standard Deviation	% CV	Specification	Pass / Fail
Run 1					≤ 1.5%	
Run 2						
Run 3						
Run 4						
Run 5						
Run 6						

Serine	Peak Area	Average Peak Area	Standard Deviation	% CV	Specification	Pass / Fail
Run 1					≤ 1.5%	
Run 2						
Run 3						
Run 4						
Run 5						
Run 6						

Cysteic Acid	Peak Area	Average Peak Area	Standard Deviation	% CV	Specification	Pass / Fail
Run 1					≤ 1.5%	
Run 2						
Run 3						
Run 4						
Run 5						
Run 6						

Method Table

Time	Buffer A*	RG003
0	100	0
20	100	0
20.1	0	100
24	0	100
24.1	100	0
Stop Time	24 min	
Post Time	12 min	

Column Temp: Refer to column insert.
 Eluant Flow Rate: Refer to column insert.
 Reactor Temperature: 130 deg C
 Reagent Flow Rate: 0.3mL/min

* Use the A Buffer corresponding to the column you have. The column insert will have the correct initial buffer listed in the method.

Sample Instrument Parameter Log

NORMAL PRESSURES AND FLOWS AT INITIAL CONDITIONS

	Flow Rate	Pressure
Analytical Pump (Column)		
Reagent Pump 1		
Reagent Pump 2		

TEMPERATURE

	Set Temperature	Actual Temperature
Analytical Column		
Heated Reactor		
Room		

Flow Diagram – Simplex

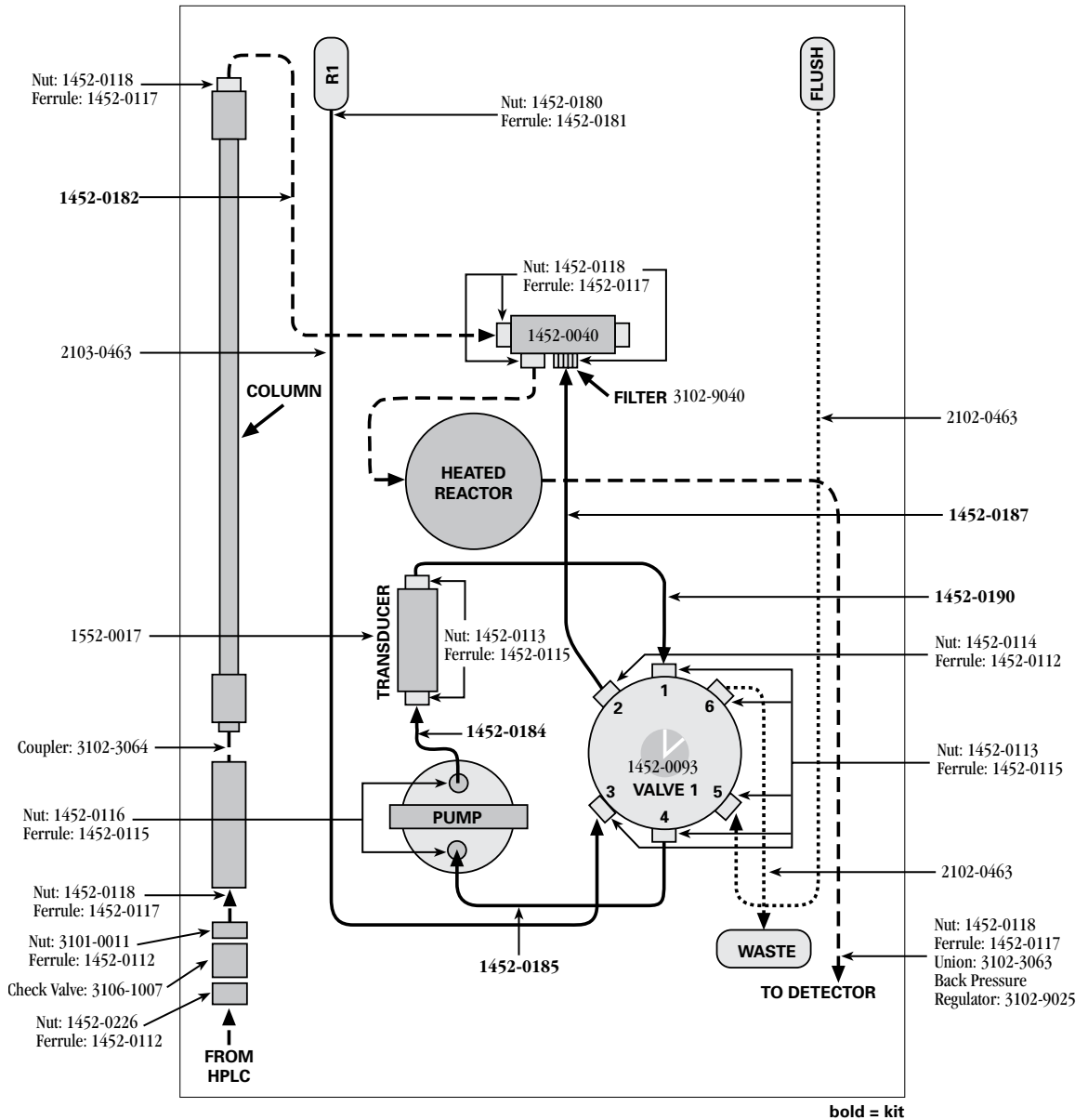

Flow Diagram – Duplex

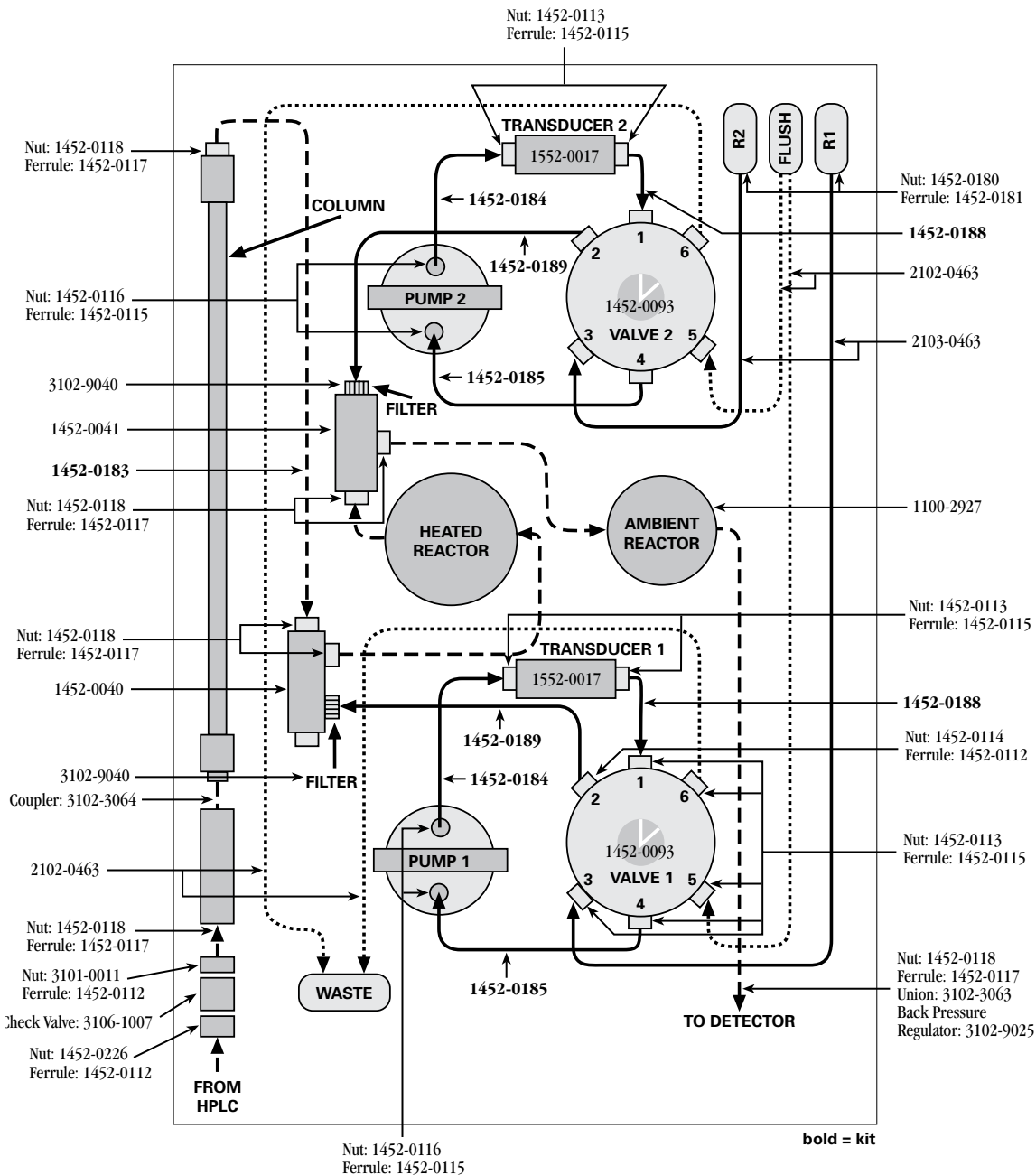

Parts List for Pinnacle PCX

CATALOG NUMBER	DESCRIPTION
Reservoirs and Caps	
3107-0137	Reservoir Bottle, safety-coated, 1L
3107-0147	Cap Assembly for 1L bottle, includes cap with integrated valve
3107-0300	Reservoir Assembly, includes 1L bottle, and cap with integrated valve
1452-0120	Bottle, Piston Wash with Cap
1452-0121	Bottle, System Flush with Cap
3107-0149	Bottle, 1L, clear
1925-0129	Cap for Flush Bottle GL - 38
1925-0130	Cap for Wash bottle GL - 38
Tubing	
2101-0212	PTFE tubing, 1/16" OD x 0.01" ID, 3ft
2101-0225	PTFE tubing, 1/16" OD x 0.025" ID, 3ft
2103-0463	Air Barrier Tubing, 1/8" OD x 1/16" ID
2104-0210	Inert PEEK tubing, 1/16" OD x 0.01" ID, 3ft
2104-0220	Inert PEEK tubing, 1/16" OD x 0.02" ID, 3ft
2101-0232	C-flex tubing, 1/4" OD x 1/8" ID, 3ft
2102-0463	FEP (clear) Tubing, 1/8" OD x 0.063" ID, 3ft
1452-0182	Tubing Assembly, Column out-Manifold, Single Pump System
1452-0183	Tubing Assembly, Column out-Manifold, Dual Pump System
1452-0184	Tubing Assembly, Pump-Transducer (2ea)
1452-0185	Tubing Assembly, Valve-Pump (2ea)
1452-0186	Tubing Assembly, Gas Manifold-Bottle (2ea)
1452-0187	Tubing Assembly, Valve-Manifold, Single Pump System
1452-0188	Tubing Assembly, Transducer-Valve, Dual Pump
1452-0189	Tubing Assembly, Valve-Manifold, Dual Pump System
1452-0190	Tubing Assembly, Transducer-Valve, Single Pump
1100-0450	Tubing Assembly, Pinnacle PCX to HPLC
1100-0460	Dead Head Plumbing Kit, Pinnacle PCX to HPLC
1100-0500	Tubing Kit, Dual Pump Pinnacle
1100-0501	Tubing Kit, Single Pump Pinnacle

Nuts and Ferrules	
3101-0011	Nut Female, 1/4-28, PEEK
1452-0112	Ferrule, Short, PEEK, 1/16", 1/4-28, pack of 5
1452-0113	Nut, Short, PEEK, 1/8", 1/4-28, pack of 5
1452-0114	Nut, Short, PEEK, 1/16", 1/4-28, pack of 5
1452-0115	Ferrule, PEEK, 1/8", 1/4-28, pack of 5
1452-0116	Nut, PEEK, 1/8", 1/4-28, pack of 5
1452-0117	Ferrule, 1/16", Lite Touch, pack of 5
1452-0118	Nut, 1/16", Lite Touch, pack of 5
1452-0180	Nut, 1/4-28, 1/8", Polypropylene, pack of 5
1452-0181	Ferrule, 1/4-28, 1/8", Tefzel, pack of 5
1452-0226	Nut, PEEK, 1/8", 1/4-28 High Pressure, pack of 5
Pump Parts	
1352-0007	Pump Cylinder, Ceramic, 70mL
1452-0038	Pump Assembly, 70mL with motor
1452-0122	Kit, Pinnacle Pump Seal
Valve Parts	
1452-0045	Valve Assembly, Valve face and motor
1452-0093	Valve face Assembly, Liquid end
1452-0201	Kit, Valve seals
1452-0202	Kit Pinnacle Valve Maintenance
Reactor Cartridge Coils & Knitted	
1452-0094	Reactor Cartridge Coil Assembly - 0.15mL 130°C
1452-0064	Reactor Cartridge Coil Assembly - 0.5mL 130°C
1452-0095	Reactor Cartridge Coil Assembly - 1.0mL 130°C
1452-0096	Reactor Cartridge Coil Assembly - 1.4mL 130°C
1452-0097	Reactor Cartridge Knitted Assembly - 2.0mL 130°C
1452-0098	Reactor Cartridge Knitted Assembly - 2.8mL 80°C
1452-0099	Reactor Cartridge Knitted Assembly - 3.0mL 80°C
1452-0100	Reactor Cartridge Knitted Assembly - 1.2mL & 1.6mL 130°C

Miscellaneous	
1100-2927	Ambient Reaction Coil
1352-0055	Drip Tray
1452-0040	Liquid Manifold with relief valve assembly
1452-0041	Liquid "T" Manifold assembly
1452-0064	Reactor Cartridge Coil Assembly - 0.5mL
1452-0141	Gas Manifold Assembly
1552-0017	Pressure Transducer Assembly
3101-0020	Plug, 1/4-28, Deldrin
3101-0030	Lplug, 10-32, 1/16", Deldrin
3102-3063	Union, PEEK ZDV
3102-3064	One Piece Coupler
3102-9025	Back Pressure Regulator, 100 psi
3102-9161	Tubing Cutter for 1/8-1/16" tubing
3106-1007	Inline Check Valve
3551-0073	Fuse, 5A Time lag high break ceramic
3560-2000	Cable, RS232
1452-0126	Relay Cable Assembly
3102-9040	Frit Replacement PEEK, 10µm
1452-0327	USB Cable

Recommended Consumables and Spare Parts

For routine maintenance and minimal interruptions to your operation, always keep the necessary consumables and spare parts available.

AMINO ACID ANALYSIS

Post-Column Reagents

CATALOG NUMBER	DESCRIPTION
O120	o-Phthalaldehyde (OPA), Chromatographic Grade™ crystals, 5g
OD104	OPA Diluent for Amino Acid Analysis, case of 4 (950mL per bottle)
3700-2000	Thiofluor™, Chromatographic Grade™ crystals, 10g
T100	TRIONE® Ninhydrin Reagent, 3-month* shelf life, 950 mL
T100C	TRIONE® Ninhydrin Reagent, 3-month* shelf life, case of 4 (950 mL per bottle)
T200	TRIONE® Two-part Ninhydrin Reagent (12 month* shelf life before mixing), prepares 4 x 950 mL

* From date of manufacture

Sodium Columns and Eluants

CATALOG NUMBER	DESCRIPTION
Columns	
1154150T	High-efficiency sodium ion-exchange column, 4.0 x 150 mm, protein, collagen, and oxidized hydrolysate
1154150	High-efficiency sodium ion-exchange column, 4.0 x 150 mm, oxidized hydrolysate
1154110T	High efficiency sodium ion-exchange column, 4.6 x 110 mm
1193250	Sodium ion-exchange column, 3.0 x 250 mm
1700-3100	GARD Holder
1700-3101	Cation GARD (2 ea)
1700-3101	Kit, GARD Holder and two Cation GARDs
Eluants	
Na270	Sodium eluant, pH 2.80, case of 4 (950mL per bottle)
1700-0112*	Sodium eluant, pH 3.15, 5% sulfolane, case of 4 (950mL per bottle)
Na328	Sodium eluant, pH 3.28, case of 4 (950mL per bottle)
Na740	Sodium eluant, pH 7.50, case of 4 (950mL per bottle)
RG011	Sodium column regenerant (950mL)
Na220	Sodium sample diluent, pH 2.20 case of 4 (250mL per bottle)
1700-0155	Calibration standard, oxidized feed hydrolysate, 0.25 µmole/mL, (5mL)

Continued on next page

Calibration Standards	
012506H	Calibration standard, protein hydrolysate, 0.25 μ mole/mL, (5mL)
012506C	Calibration standard, collagen hydrolysate, 0.25 μ mole/mL, (5mL)
1700-0070	Amino acid test mixture, 3-component, 0.25 mmol/mL (1.5mL)

* For 1154150 columns with serial numbers after 1314

Lithium Columns and Eluants

CATALOG NUMBER	DESCRIPTION
Columns	
0354675T	High-efficiency lithium ion-exchange column, 4.6 x 75 mm
0354100T	High-efficiency lithium ion-exchange column, 4.0 x 100 mm
0393250	Lithium ion-exchange column, 3.0 x 250 mm
1700-3100	GARD Holder
1700-3101	Cation GARD (2 ea)
1700-3101	Kit, GARD Holder and two Cation GARDs
Eluants	
1700-1125	Lithium eluent pH 2.80 case of 4 (950mL per bottle)
Li220	Lithium sample diluent pH 2.36 (950mL)
Li275	Lithium eluent pH 2.75 case of 4 (950mL per bottle)
Li280	Lithium eluent pH 2.75 case of 4 (950mL per bottle)
Li292	Lithium eluent pH 2.92 case of 4 (950mL per bottle)
Li365	Lithium eluent pH 3.65 case of 4 (950mL per bottle)
Li375	Lithium eluent pH 3.75 case of 4 (950mL per bottle)
Li750	Lithium eluent pH 7.50 case of 4 (950mL per bottle)
RG003	Lithium column regenerant (950mL)
Calibration Standards	
011006P	Calibration standard, with norleucine, 0.25 μ mole/mL (5mL)
012006P	standard without norleucine, 0.25 μ mole/mL (5mL)
1700-0070	Amino acid test mixture, 3-component, 0.25 μ mole/mL (1.5mL)
1700-0180	Native Sample Standard, acidics and neutrals, in 0.1 N HCl, 5 mL
1700-0175	Native Sample Standard, basics, in 0.1 N HCl, 5 mL
1700-0170	Native Sample Standard without Norleucine & Alpha-Amino-Beta-guanidinopropionic acid, in 0.2 N Lithium citrate buffer pH 2.36, 5 mL
Sample Preparation	
SP 100	SERAPREP™, for sample preparation of serum, (250mL)
UP 100	URIPREP™, for sample preparation of urine (250mL)

CARBAMATE ANALYSIS**Reagents**

CATALOG NUMBER	DESCRIPTION
O120	o-Phthalaldehyde, Chromatographic Grade™ crystals, 5 g
3700-2000	Thiofluor™, Chromatographic Grade™ crystals, 10 g
CB910	OPA Diluent for Carbamate Pesticide Analysis, 4 x 950 mL
CB130	Hydrolysis Reagent for Carbamate Pesticide Analysis, 4 x 950 mL
CB130.2	Hydrolysis Reagent for EPA 531.2, 4 x 950mL
1700-0063	Carbamate Test Mixture, qualitative sample, 12 components, 1.5 mL, 2.5 µg/mL
1700-0132	ChlorAC™ Buffer for preservation of aqueous carbamate samples, 250 mL

Columns & Guards

CATALOG NUMBER	DESCRIPTION
0840250	Carbamate C ₈ column, 4.0 mm ID x 250 mm (with carbamate test mixture 1700-0063)
1846150	Carbamate C ₁₈ column, 4.6 mm ID x 150 mm (with carbamate test mixture 1700-0063)
0846250	Carbamate C ₈ column, 4.6 mm ID x 250 mm (with carbamate test mixture 1700-0063)
18ECG002	Replacement Carbamate Guard Cartridges - (Qty. 2)
18ECG001	Guard Cartridge holder with 3 guard cartridges

GLYPHOSATE ANALYSIS**Reagents**

CATALOG NUMBER	DESCRIPTION
O120	o-Phthalaldehyde, Chromatographic Grade crystals, 5 g
3700-2000	Thiofluor, Chromatographic Grade crystals, 10 g
GA104	OPA Diluent for glyphosate analysis, 4 x 950 mL
GA116	Hypochlorite Diluent for glyphosate analysis, 4 x 950 mL
K200	Eluent for glyphosate analysis, 4 x 950 mL
RG019	Column Regenerant for glyphosate analysis, 4 x 950 mL
1700-0080	Test mixture, 2.5 µg/mL each glyphosate and AMPA, 1.5 mL
1700-0140	RESTORE for removal of metal ion contamination from glyphosate column and guard, 250 mL

Columns & Guards

CATALOG NUMBER	DESCRIPTION
1954150	Glyphosate column, 4.0 mm ID x 150 mm (with Glyphosate test mixture 1700-00??)
1700-3100	GARD Holder
1700-3101	Cation GARD (2 ea)
1700-3101	Kit, GARD Holder and two Cation GARDs
1705-0001	Sample clean up cartridge, SPE column caution exchange (10pkg)

Limited Warranty

INSTRUMENTS

Pickering Laboratories, Inc., (Pickering) Instruments are warranted to be free of defects in material and workmanship under normal installation, use, and maintenance, for a period of one year from the date of delivery to the Customer. Pickering will replace or repair, without cost, any defective items. Expendable items such as check valves, pistons, piston seals, and filters are excluded from this warranty. In addition, physical damage, poor quality reagent- and sample-induced damage, and instrument damage due to Customer's misuse are not covered by this warranty.

ANALYTICAL COLUMNS

Pickering's Analytical Columns are warranted to be free of defects in materials and workmanship under normal installation, use, and maintenance, for the warranted time beginning from the date of delivery to the original Customer. Pickering will replace the Analytical Column under warranty if found defective in material or workmanship. However, the warranty is void if the Analytical Column was damaged due to Customer's misuse. Columns are warranted for 90 days.

HOW TO OBTAIN WARRANTY SERVICE

If there is a problem with your Instrument or Analytical Column within the Warranty period, do not attempt to repair. Immediately notify Pickering at (800) 654-3330; if calling from outside U.S.A., use (650) 694-6700. If the Instrument or Analytical Column was not purchased directly from Pickering, please contact the vendor where it was purchased. Any Instrument, part of the Instrument, or Analytical Column returned to Pickering for examination or repair shall have Pickering's prior approval (call for a Returned Goods Authorization number) and be sent prepaid by the Customer. Return transportation will be at Pickering's expense if the Instrument, part of the Instrument, or Analytical Column is found to be defective and under warranty.

Pickering Laboratories, Inc.
1280 Space Park Way
Mountain View, CA 94043
U.S.A.

References

INSTRUMENTATION

- M.V. Pickering, "Assembling an HPLC post-column system: practical considerations," LC•GC, 6, 11 (1988) 994–997.*
- M.V. Pickering, "Modifying HPLC equipment to tolerate corrosive solutions," LC•GC, 6, 9 (1988) 800–809.*
- J.W. Dolan and L.R. Snyder, "Troubleshooting LC Systems," Humana Press, Clifton, NJ (1989).

* Reprints available from Pickering Laboratories

AMINO ACID ANALYSIS

- D.H. Spackman, W.H. Stein and S. Moore, Anal. Chem., 30 (1958) 1190.
- M. V. Pickering, LC•GC, 7 (1988) 484.*
- J. A. Grunau and J.M. Swiader, J. Chromatogr., 594 (1992) 165.*
- A. A. Boulton, G. B. Baker and J.D. Wood (Eds.), "Neuromethods 3, Amino Acids," Humana Press, Clifton, NJ (1985), Chapter 1.

CARBAMATES ANALYSIS

- "Measurement of N-methyl carbamoyloximes and N-methyl carbamates in drinking water by direct aqueous injection LC with post-column derivatization," EPA Method 531 by D.L. Foerst, EPA/600/4-851054 (1986); Method 5, revised by T. Engels, National Pesticide Survey, Battelle Columbus Lab (1987); Method 531.1, revised by R.L. Graves, EPA, Environmental Monitoring and Support Laboratory, Cincinnati (1989).
- M. W. Dong, F.L. Vandemark, W.M. Reuter, and M.V. Pickering, "Carbamate pesticides analysis by liquid chromatography," Amer. Environ. Lab., 2(3) (1991) 14–27.
- K.M. Hill, R.H. Hollowell, and L. D. Dal Cortivo, "Determination of N-methylcarbamate pesticides in well water by liquid chromatography with post-column fluorescence derivatization," Anal. Chem., 56 (1984) 2465–2475.
- H. Frister, H. Meisel, and E. Schlimme, "OPA Method Modified by Use of N, N-Dimethyl-2-mercaptoethylammonium Chloride," Fresenius Z. Anal. Chem., 330 (1988) 631–633.

GLYPHOSATE ANALYSIS

- J.E. Cowell, "Analytical Residue Method for N-Phosphono-methylglycine and Aminomethylphosphonic acid in Environmental Water," Monsanto Method Number 86-63-1, 1987
- Environmental Protection Agency Draft Method 597: "Analysis of Glyphosate in Drinking Water by Direct Aqueous Injection LC with Post-Column Derivatization."

INDEX

- A**
 - Air Barrier tubing** 2.6, 2.9, 2.14, 3.2, 3.5, 3.6, 3.12, 8.18
 - Ambient Reactor** 2.7, 3.11, 5.7, 5.8, 8.3
 - Amino Acid** 6, 7, 3.1, 3.3, 3.9, 3.14, 3.15, 6.2-5, 6.2-18, 8.11, 8.13, 8.21, 8.25
 - AMPA** 6.4, 6.4-1, 6.4-2, 6.4-3, 6.4-5, 6.4-6, 8.23
 - Analytical Method** 4.14
 - AOAC** 6.2-2, 6.3, 6.3-1, 6.3-2, 6.4-1
 - Aqueous Sample** 6.3-6, 6.3-7, 6.3-9, 6.3-11, 6.3-12, 6.4-7
 - Automatic Shutdown** 3.15, 4.18, 5.4
 - Autosampler** 6, 3.3, 3.8, 6.2, 6.3

- B**
 - Back-flow** 2.13, 5.3, 6.3-12, 6.4-6
 - Background Signal** 2
 - Back Pressure Regulator** 3.11, 5.2, 6.2-19, 8.20
 - Buffer** 7, 3.10, 3.11, 5.2, 5.3, 5.6, 6.2-3, 6.2-20, 6.3-3, 6.3-12, 6.4-7, 8.11, 8.12, 8.13, 8.14, 8.22, 8.23

- C**
 - Calcium Hypochlorite** 6.4-3
 - Calibration** 6, 6.3-12, 6.4-7, 8.21, 8.22
 - Cap** 2.6, 3.12, 3.13, 5.9, 5.11, 5.13, 5.14, 5.15, 6.2-3, 6.2-4, 6.3-4, 6.4-3, 8.18
 - Carbamate** 6, 3.1, 3.4, 3.10, 3.15, 6.3, 6.3-1, 6.3-2, 6.3-3, 6.3-5, 6.3-6, 6.3-7, 6.3-8, 6.3-9, 6.3-10, 6.3-11, 6.3-12, 8.10, 8.25
 - Check Valve** 2.3, 2.13, 3.9, 3.10, 5.3, 8.20
 - Check Valves** 8.24
 - Chemistry** 6, 3.4
 - ChlorAC** 6.3-3, 8.23
 - Collagen Hydrolysate** 6.2-13, 6.2-15, 6.2-16, 8.22
 - Column and Guard Installation** 3.10
 - Column Connections** 2.3, 3.2
 - Column Oven** 2.3, 2.4, 2.11, 3.5, 3.10, 3.11, 4.2, 4.8, 5.6, 6.2-5, 6.2-6, 6.2-8, 6.2-11, 6.2-12, 6.2-13
 - Column Pressure** 5.3, 6.2-18, 6.4-4, 7.6, 7.11, 7.12
 - Column Temperature** 4.6, 4.8, 6.2-6, 6.2-8, 6.2-11, 6.2-20, 6.3-6, 6.3-8, 6.3-10, 6.3-11, 6.4-4, 7.9, 7.10, 8.8
 - Computer Connections** 3.6
 - Computer Requirements** 3.4, 4.1
 - Configure** 3.6, 3.7, 4.6, 8.3
 - Consumables** 8.21
 - Contaminants** 3.16, 4.18, 5.3, 5.4, 6.2-19, 6.3-4, 6.3-12, 6.4-3, 6.4-6, 7.5, 7.6
 - Contamination** 2.5, 2.6, 3.8, 3.12, 3.13, 5.3, 6.2-18, 6.2-19, 6.4-1, 6.4-6, 7.4, 7.5, 7.6, 7.7, 8.23

INDEX

- D**
 - Dead-Head** 6, 3.9
 - Deposits in Reactor** 7.7
 - Designing a Post-column System** 4
 - Detector Connections** 2.8, 3.11
 - Detector Settings** 4.14
 - Display Module** 2.10

- E**
 - Electronics Compartment** 2.11
 - Eluant** 6, 2, 2.3, 3.1, 3.2, 3.10, 3.14, 3.15, 3.16, 4.18, 5.2, 5.3, 5.4, 5.5, 5.6, 6.2, 6.2-18, 6.2-19, 6.4-1, 6.4-7, 7.3, 7.4, 7.5, 7.6, 7.12, 8.9, 8.11, 8.13, 8.14, 8.21, 8.22
 - Empty Pump** 3.13, 4.4, 4.15, 5.9
 - Enable** 3.14, 4.3, 4.4, 4.5, 4.15, 5.5, 8.4, 8.6
 - EPA** 5.3, 6.3-2, 6.3-3, 6.3-12, 6.4-3, 6.4-7, 8.23, 8.25
 - Equilibration** 3.14, 4.8, 4.9, 4.10, 4.12, 4.16, 4.18, 6.2-7, 6.2-8, 6.2-9, 6.2-10, 6.2-16, 6.2-17, 6.2-18, 6.4-4, 6.4-6, 6.4-7, 7.5, 7.8
 - Error Messages** 4.3, 4.7, 7.2, 7.9, 7.10
 - Ethernet** 3, 5, 2.11, 2.12, 3.7, 4.1, 7.9

- F**
 - Ferrules** 2.6, 3.2, 3.5, 5.1, 5.7, 8.19
 - Fittings** 2.13, 3.2, 3.11, 5.2, 5.3, 5.8, 5.9, 6.2-18, 7.3, 7.6
 - Flow Path** 2.2, 3.3, 7.3, 7.6, 7.11
 - Fluidics Panel** 2.6, 2.7, 3.5, 3.11, 5.6, 5.8
 - Flush Method** 4.9, 4.11, 4.17, 5.5
 - Flush Pump** 3.13, 4.4, 5.9, 5.12, 5.16, 7.3
 - Flush Reservoir** 2.7, 3.12, 3.13
 - Fuse** 3, 2.11, 2.12, 5.2, 5.16, 8.20

- G**
 - Gas Connections** 3.5, 3.6
 - Gas Manifold** 2.6, 2.9, 2.14, 8.18, 8.20
 - Glyphosate** 5, 6, 3.1, 3.3, 3.10, 3.15, 6.4, 6.4-1, 6.4-2, 6.4-3, 6.4-4, 6.4-5, 6.4-6, 6.4-7, 7.4, 7.5, 7.7, 7.12, 8.9, 8.23, 8.25
 - Grease Deposits** 7.7, 7.11

INDEX

- H**
 - Heated Reactor** 2, 2.7, 2.9, 2.13, 2.14, 3.11, 3.15, 4.2, 4.17, 5.2, 5.3, 5.5, 5.6, 5.8, 6.2-19, 7.4, 7.7, 7.10, 8.3, 8.15
 - Help** 2, 4, 6, 2.5, 4.5, 4.7, 4.9, 4.11, 5.2, 7.2, 7.4, 7.8
 - High Pressure** 5.3, 6.2-18, 7.6, 7.9, 8.19
 - HPLC Slowdown method** 3.16, 4.18, 5.4
 - HPLC Synchronization** 4.1
 - HPLC System Requirements** 3.3
 - Hydrindantin** 6.2-1, 7.4, 7.7
 - Hydrolysis Reagent** 6, 6.3-3, 6.3-4, 6.3-5, 7.5, 8.10, 8.23

- I**
 - Important Practical Considerations** 4.9, 4.16
 - Installation** 1, 3, 2.10, 3.2, 3.4, 3.6, 3.10, 4.3, 4.6, 4.15, 5.1, 6.3-3, 7.5, 8.2, 8.4, 8.6, 8.7, 8.24
 - Installation Qualification** 8.2, 8.7
 - Ion-exchange** 3.16, 4.18, 5.3, 5.4, 6.2, 6.2-1, 6.2-18, 6.3-12, 7.6, 8.21, 8.22
 - Ion-exclusion** 6.2-1
 - Iron Contamination** 6.4-1, 6.4-6, 7.5, 7.7, 7.12

- L**
 - LCD** 3, 2.10, 2.14, 3.6, 3.7, 4.3
 - Leaks** 3.6, 3.10, 5.2, 5.7, 5.8, 6.2-18, 6.2-19, 7.3
 - Lithium ion-exchange** 6.2, 8.22
 - Log Files** 4.7, 7.2, 7.8
 - Long-Term Shutdown** 5.4, 5.5

- M**
 - Maintenance** 1, 4.5, 5.2, 5.5, 5.6, 5.9, 5.10, 5.12, 7.2, 7.6, 8.6, 8.19, 8.21, 8.24
 - Manual Shutdown** 3.15, 4.17, 5.4
 - Methanolic Samples** 6.3-8, 6.3-10, 6.3-12
 - Mineral Deposits** 7.4, 7.11
 - Mixing Manifold** 2.7, 5.6, 5.8
 - MODE button** 3.7, 3.8
 - MSDS** 3.1, 5.2
 - MSUD** 6.2-10

- N**
 - Network** 3, 5, 2.10, 2.12, 3.4, 3.6, 3.7, 4.1, 4.6
 - Ninhydrin** 7, 3.2, 6.2, 6.2-1, 6.2-2, 6.2-4, 6.2-20, 8.21
 - Noisy Baseline** 7.4
 - Nuts** 2.6, 3.2, 3.5, 5.1, 5.7, 8.19

INDEX

- O**
 - OPA** 6, 7, 3.2, 4.12, 5.3, 6.2, 6.2-2, 6.2-4, 6.2-5, 6.2-19, 6.3, 6.3-2, 6.3-4, 6.3-5, 6.3-12, 6.4-1, 6.4-3, 6.4-6, 7.5, 8.9, 8.10, 8.21, 8.23, 8.25
 - Operational Qualification** 8.2, 8.4, 8.6
 - Organic Solvents** 3.10, 6.2-18, 6.3-12, 6.4-7, 7.11
 - O-ring** 2.4, 5.10, 5.14, 5.15, 7.10
 - Over-Pressure Relief** 2.7, 2.13, 5.6, 7.4
 - Oxidized Feed Hydrolysate** 8.21
 - Oxidizing Reagent** 6.4-2, 6.4-3, 7.7

- P**
 - Parameter Log** 5.1, 7.2, 7.3, 8.15
 - Parts List** 3.10, 8.18
 - Pause Sequence** 4.5
 - Peak Identification** 6.2-6, 6.2-7, 6.2-8, 6.2-9, 6.2-11, 6.2-14, 6.2-15, 6.2-17
 - Physiological Fluid** 6.2-2, 6.2-6, 6.2-7, 6.2-9
 - Piston Head** 5.13, 5.14, 5.15
 - PKU** 6.2-10
 - Post Column Conditions** 6.2-4
 - Post-Column Derivatization** 2, 1, 3.1, 6.2, 6.3, 6.4, 8.25
 - Precautions** 6.2, 6.2-18, 6.3, 6.3-12, 6.4, 6.4-6
 - Precipitate** 2, 5.2, 5.3, 6.2-19, 6.3-3, 6.3-4, 6.3-12, 6.4-3, 6.4-6
 - Pre-Column Check Valve** 3.9, 3.10, 5.3
 - Pressure Transducer** 6, 2.7, 5.6, 5.7, 8.20
 - Primary Amines** 6.2-1, 6.2-2, 6.2-19
 - Priming** 3.10
 - Protein Hydrolysate** 6.2, 6.2-2, 6.2-12, 6.2-16, 6.2-17, 8.22
 - Pump Flush** 5.11
 - Pump Parts** 8.19
 - Pump Seal** 5.2, 5.12, 5.14, 7.3, 7.4, 8.19

- R**
 - Reactor Temperature** 3.15, 4.2, 4.6, 4.7, 4.8, 4.18, 5.4, 7.2, 7.5, 7.10, 8.14
 - Reagent Backflow** 7.6, 7.11
 - Reagent Filter** 2.7, 3.2, 5.2, 5.6, 5.7, 7.7, 7.9
 - Reagent Preparation** 6, 7, 6.2-3, 6.3-3, 6.4-2, 7.5
 - Reagent Pressure** 5.2, 7.3
 - Reagent Pump** 2, 1, 2, 2.4, 2.9, 2.14, 3.2, 3.13, 3.14, 4.2, 4.6, 4.9, 4.10, 7.3, 7.5, 8.15
 - Reagent Reservoir** 2, 5, 2.5, 2.7, 2.9, 2.14, 3.2, 3.12, 6.2-3, 6.2-4, 6.3-5, 6.4-2, 6.4-3
 - Reagent Stability** 2
 - Reagent Valve** 2.5

INDEX

- R**
 - Regenerant** 3.3, 3.16, 4.18, 5.4, 6.2-18, 6.2-20, 7.5, 7.7, 7.11, 7.12, 8.9, 8.21, 8.22, 8.23
 - Relay** 3, 5, 2.11, 2.12, 3.4, 3.6, 3.14, 4.1, 4.2, 4.3, 4.6, 4.14, 4.15, 7.8, 8.20
 - Rotor Seal** 6, 3.3, 7.5, 7.6
 - Running a Chromatogram** 3.14

- S**
 - Safety Features** 2.13
 - Sample Chromatogram** 6.2, 6.2-4, 6.2-6, 6.3, 6.3-5, 6.4, 6.4-5
 - Sample Preparation** 6.2, 6.2-2, 6.3, 6.3-2, 6.3-3, 6.4, 6.4-1, 7.5, 8.22
 - Seal Replacement** 2.9, 5.12, 5.14
 - Secondary Amines** 6.2-1, 6.2-2, 6.2-19
 - Sequence** 1, 3.14, 3.15, 4.1, 4.3, 4.4, 4.5, 4.7, 4.9, 4.10, 4.11, 4.13, 4.14, 4.15, 4.16, 4.17, 4.18, 5.4, 5.5, 5.12, 7.8, 7.9, 8.4, 8.5
 - SERAPREP** 6.2-3, 8.22
 - Shelf Life** 6.2-19, 8.21
 - Shipping** 4.5, 5.6
 - Shutdown** 2.3, 2.5, 3.15, 4.11, 4.17, 4.18, 5.2, 5.3, 5.4, 5.5, 5.8, 5.12, 5.16, 6.2-18, 6.3-12, 6.4-6, 7.4, 7.6
 - Silica** 5.3, 7.4, 7.11, 7.12
 - Site Requirements** 1, 4, 2.12, 3.2, 8.2
 - Sodium Hypochlorite** 6, 7, 6.2-5, 6.4-2
 - Sodium ion-exchange** 6.2, 8.21
 - Software** 4, 5, 2.3, 3.4, 3.6, 3.13, 3.14, 3.15, 4.2, 4.4, 4.5, 4.6, 4.7, 4.9, 4.10, 4.11, 4.12, 4.13, 4.14, 4.15, 4.16, 4.17, 5.4, 5.5, 5.6, 5.9, 5.12, 7.2, 7.8, 7.9, 7.10, 8.3
 - Spare Parts** 8.21
 - Standard Configurations** 2.14
 - Standards** 6, 3.1, 6.2, 6.3-3, 7.5, 8.22
 - Stop/Reset** 4.5, 4.17
 - Storage** 3.10, 3.15, 3.16, 4.5, 4.9, 4.18, 5.1, 5.4, 5.5, 5.6, 6.3-3, 7.5
 - Symbols and Warnings** 2

INDEX

- T**
 - Technical Support** 7.1, 7.6
 - Tefzel** 6, 3.3, 6.2, 8.19
 - Thiofluor** 6, 5.3, 6.2-2, 6.2-4, 6.2-5, 6.2-19, 6.3-2, 6.3-4, 6.3-5, 6.3-12, 6.4-1, 6.4-3, 6.4-4, 6.4-6, 8.9, 8.10, 8.21, 8.23
 - Trione** 7, 3.2, 3.3, 3.14, 6.2, 6.2-3, 6.2-4, 6.2-19, 7.4, 7.5, 7.7, 8.11, 8.13, 8.21
 - Troubleshooting** 1, 6.3-2, 7.2, 7.3, 7.7, 7.8, 7.9, 7.10, 8.25
 - Tutorials** 4.11

- U**
 - URIPREP** 6.2-3, 8.22
 - USB** 3, 5, 2.11, 3.4, 3.6, 4.1, 4.6, 7.9, 8.20

- V**
 - Valve Maintenance** 5.9, 5.10, 8.19
 - Valve Parts** 8.19
 - Vegetable Samples** 6.4, 6.4-1

- W**
 - Warranty** 5.1, 5.2, 5.3, 6.2-19, 6.3-4, 6.3-12, 6.4-3, 6.4-6, 8.24
 - Water Samples** 3.3, 3.4, 6.3-2, 6.4-1, 6.4-2, 7.4